

Directional control valves, direct operated,
with electrical position feedback and
integrated electronics (OBE)

Type 4WRPEH

RE 29121

Edition: 2019-02

Replaces: 2018-01

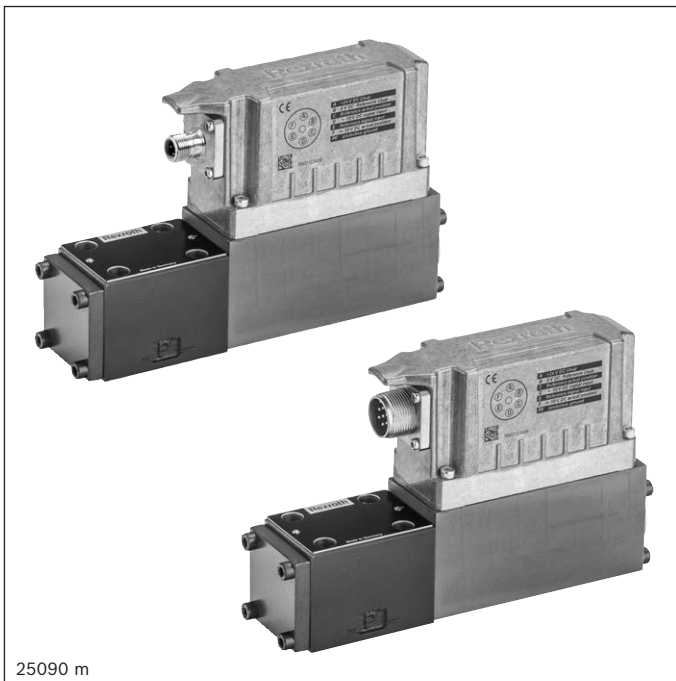

25090 m

- ▶ Size 6
- ▶ Component series 3X
- ▶ Maximum operating pressure 350 bar
- ▶ Rated flow 4 ... 40 l/min

CE

 **IO-Link**

Features

- ▶ Reliable - proven and robust design
- ▶ Safe - fail-safe position of the control spool in switched-off condition
- ▶ Energy-efficient - no pilot oil demand
- ▶ High quality - control spool and sleeve in servo quality
- ▶ Flexible - suitable for position, velocity and pressure control
- ▶ Precise - high response sensitivity and little hysteresis
- ▶ IO-Link interface, optional

Contents

Features	1
Ordering code	2
Symbols	3
Function, section	4
Technical data	5 ... 8
Electrical connections and assignment	9
Block diagram/controller function block	10
Characteristic curves	11 ... 19
Dimensions	20, 21
Accessories	21
Further information	22

Ordering code

01	02	03	04	05	06	07	08	09	10	11	12	13	14	15	16	
4	WRP	E	H	6		B			-	3X	/		/		24	*

01	4 main ports	4
02	Directional control valve, direct operated	WRP
03	With integrated electronics	E
04	Control spool/sleeve	H
05	Size 6	6
06	Symbols e.g. C, C1, C5 etc.; for possible design, see page 3	
07	Installation side of the inductive position transducer	B

Rated flow ($\Delta p = 35$ bar/control edge)

08		Flow characteristic		
		"L"	"P"	
	4 l/min	✓	✓ (Inflection at 20%)	04
	12 l/min	✓	-	12
	15 l/min	-	✓ (Inflection at 60%)	15
	24 l/min	✓	-	24
	25 l/min	-	✓ (Inflection at 60%)	25
	40 l/min	✓	✓ (Inflection at 40%)	40

Flow characteristic

09	Linear	L
	Inflected characteristic curve, linear	P
10	Component series 30 ... 39 (30 ... 39: unchanged installation and connection dimensions)	3X

Seal material (observe compatibility of seals with hydraulic fluid used, see page 6)

11	NBR seals	M
	FKM seals	V
12	Without damping plate	no code
	With damping plate	D
13	Supply voltage of the integrated electronics: 24VDC	24

Interfaces of the control electronics

14	Command value input ± 10 V	A1
	Command value input 4 ... 20 mA	F1
	IO-Link interface	L1
	Command value ± 10 mA, actual value 4 ... 20 mA, release (connector 6+PE)	C6
15	Without electronics protection membrane	no code
	With electronics protection membrane	-967
16	Further details in the plain text	

Symbols

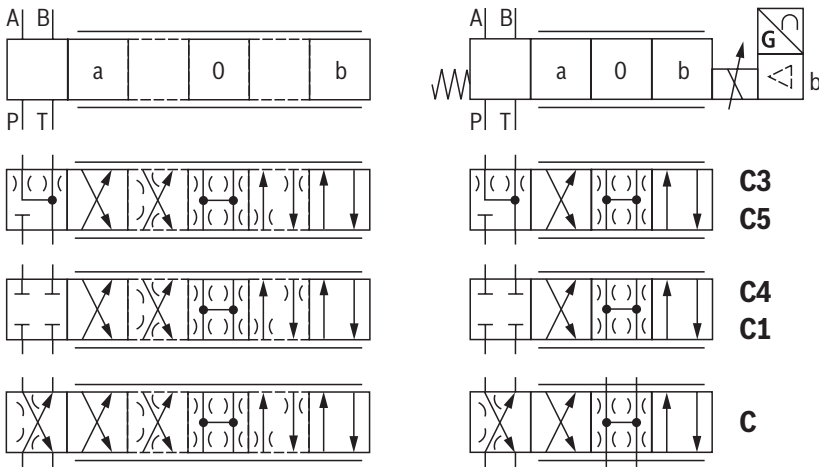

With symbols C5 and C1: ¹⁾

P → A: $q_{V \text{ nom}}$ B → T: $q_{V \text{ nom}}/2$

P → B: $q_{V \text{ nom}}/2$ A → T: $q_{V \text{ nom}}$

Notice:

Representation according to DIN ISO 1219-1.
Hydraulic interim positions are shown by dashes.

¹⁾ $q_{V \text{ nom}}$ 2:1 in connection with flow characteristic "P" only for rated flow 40 l/min (version "40")

Flow characteristic

Symbol	Linear characteristic curve (Version "L")	Inflected characteristic curve (version "P")		
		Inflection 60% ($q_{V \text{ nom}} = 15.25 \text{ l/min}$)	Inflection 40%	Inflection 20%
C3, C5				
C4, C1				
C				

Function, section

Valves of type 4WRPEH are direct operated directional control valves with electrical position feedback and integrated electronics (OBE).

Set-up

The 4WRPEH high-response valve mainly consists of:

- ▶ Valve housing with control spool and sleeve in servo quality (1)
- ▶ Control solenoid with position transducer (2) (optionally with electronics protection membrane (5))
- ▶ On-board electronics (OBE) (3) with analog or IO-Link interface (4) (optionally with damping plate (6))

Function

The integrated electronics (OBE) compares the specified command value to the position actual value. In case of control deviations, the stroke solenoid will be activated. Due to the changed solenoid force, the control spool is adjusted against the spring. Stroke/control spool cross-section is controlled proportionally to the command value. In case of a command value presetting of 0, the electronics adjusts the control spool against the spring to central position. In deactivated condition, the spring is untensioned to a maximum and the valve is in fail-safe position.

Control solenoid shut-off

In case of the following errors, the control solenoids are de-energized by the integrated electronics (OBE) and the control spool is set to fail-safe position:

- ▶ Falling below the minimum supply voltage

- ▶ Only at interface "F1":
 - Falling below the minimum current command value of 2 mA (includes cable break of the command value line (current loop))
- ▶ Only at interface "L1":
 - Enable inactive, communication interruption (watchdog)
 - In case of internal IO-Link error
- ▶ Only at interface "C6":
 - Additionally release inactive

Damping plate "D"

The damping plate reduces the acceleration amplitudes on the on-board electronics (frequencies >300 Hz).

Notice:

Use of the damping plate is not recommended for applications with mainly low-frequency excitation <300 Hz

Electronics protection membrane "-967"

To prevent condensate formation in the housing of the integrated electronics (OBE), an electronics protection membrane (5) can be used.

Recommended for use outside industry-standard conditions with high ambient air humidity and significant cyclic temperature changes (e.g. outdoors).

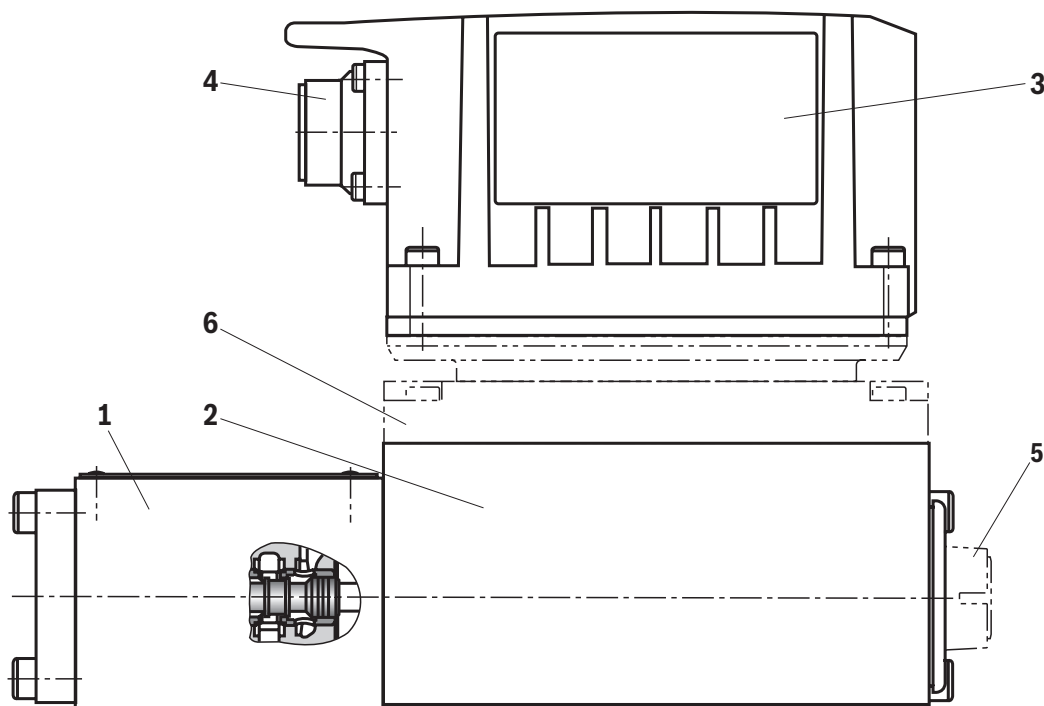

Technical data

(for applications outside these values, please consult us!)

General		
Design	Spool valve, direct operated, with steel sleeve	
Actuation	Proportional solenoid with position control, OBE	
Type of connection	Subplate mounting, porting pattern according to ISO 4401	
Installation position	any	
Ambient temperature range	°C -20 ... +60	
Transport temperature	°C -30 ... +80	
Maximum storage time	Years 1 (if the storage conditions are observed; refer to the operating instructions 07600-B)	
Sine test according to DIN EN 60068-2-6	▶ Without damping plate	10 ... 2000 Hz / maximum of 10 g / 10 cycles / 3 axes
	▶ With damping plate ¹⁾	10 ... 2000 Hz / maximum of 10 g / 10 cycles / 3 axes
Noise test according to DIN EN 60068-2-64	▶ Without damping plate	20 ... 2000 Hz / 10 g _{RMS} / 30 g peak / 30 min. / 3 axes
	▶ With damping plate ¹⁾	20 ... 2000 Hz / 10 g _{RMS} / 30 g peak / 24 h / 3 axes
Transport shock according to DIN EN 60068-2-27	▶ Without damping plate	15 g / 11 ms / 3 shocks / 3 axes
	▶ With damping plate ¹⁾	15 g / 11 ms / 3 shocks / 3 axes
Shock according to DIN EN 60068-2-27	▶ With damping plate ¹⁾	35 g / 6 ms / 1000 shocks / 3 axes
Weight	kg 2.9	
Maximum relative humidity (no condensation)	% 95	
Maximum solenoid surface temperature	°C 150	
MTTF _d value according to EN ISO 13849	Years 150 (for further details see data sheet 08012)	
Conformity	<ul style="list-style-type: none"> ▶ CE according to EMC directive 2014/30/EU, tested according to EN 61000-6-2 and EN 61000-6-3 ▶ RoHS directive 2015/65/EU ▶ REACH ordinance (EC) no. 1907/2006 	

Hydraulic		
Maximum operating pressure	▶ Port A, B, P	bar 350
	▶ Port T	bar 250
Rated flow at $\Delta p = 35$ bar/control edge ²⁾	l/min	4 12 15 24/25 40
Hydraulic fluid		see table page 6
Viscosity range	▶ Recommended	mm ² /s 20 ... 100
	▶ Maximum admissible	mm ² /s 10 ... 800
Hydraulic fluid temperature range (flown-through)	°C	-20 ... +70
Maximum admissible degree of contamination of the hydraulic fluid cleanliness class according to ISO 4406 (c)		Class 18/16/13 ³⁾
Limitation of use (Δp) with regard to the transition to fail-safe (values apply to summated edge)	▶ Symbols C3, C5, C	bar 350 350 350 350 160
	▶ Symbols C1, C4	bar 350 350 280 250 100
Leakage flow at 100 bar	▶ Linear characteristic curve "L"	cm ³ /min < 180 < 300 – < 500 < 900
	▶ Inflected characteristic curve "P"	cm ³ /min < 150 – < 180 < 300 < 450

¹⁾ Not recommended for applications with mainly low-frequency excitation < 300 Hz

²⁾ Flow for deviating Δp (control edge):

$$q_x = q_{Vnom} \cdot \sqrt{\frac{\Delta p_x}{35}}$$

³⁾ The cleanliness classes specified for the components must be adhered to in hydraulic systems. Effective filtration prevents faults and simultaneously increases the life cycle of the components.

For the selection of filters, see www.boschrexroth.com/filter.

Technical data

(for applications outside these values, please consult us!)

Hydraulic fluid	Classification	Suitable sealing materials	Standards	Data sheet
Mineral oils	HL, HLP, HLPD, HVLP, HVLPD	NBR, FKM	DIN 51524	90220
Bio-degradable	▶ Insoluble in water	HETG	ISO 15380	90221
		HEES		
	▶ Soluble in water	HEPG	ISO 15380	
Flame-resistant	▶ Water-free	HFDU (glycol base)	ISO 12922	90222
		HFDU (ester base)		
		HFDR		
	▶ Containing water	HFC (Fuchs: Hydrotherm 46M, Renosafe 500; Petrofer: Ultra Safe 620; Houghton: Safe 620; Union: Carbide HP5046)	NBR	ISO 12922

**Important information on hydraulic fluids:**

- ▶ For further information and data on the use of other hydraulic fluids, please refer to the data sheets above or contact us.
- ▶ There may be limitations regarding the technical valve data (temperature, pressure range, life cycle, maintenance intervals, etc.).
- ▶ The ignition temperature of the hydraulic fluid used must be 50 K higher than the maximum surface temperature.
- ▶ **Bio-degradable and flame-resistant – containing water:**
If components with galvanic zinc coating (e.g. version "J3" or "J5") or parts containing zinc are used, small amounts of dissolved zinc may get into the hydraulic system and cause accelerated aging of the hydraulic fluid. Zinc soap may form as a chemical reaction product, which may clog filters, nozzles and solenoid valves - particularly in connection with local heat input.

▶ Flame-resistant – containing water:

- Due to increased cavitation tendency with HFC hydraulic fluids, the life cycle of the component may be reduced by up to 30% as compared to the use with mineral oil HLP. In order to reduce the cavitation effect, it is recommended - if possible specific to the installation - to back up the return flow pressure in ports T to approx. 20% of the pressure differential at the component.
- Dependent on the hydraulic fluid used, the maximum ambient and hydraulic fluid temperature must not exceed 50 °C. In order to reduce the heat input into the component, the command value profile is to be adjusted for proportional and high-response valves.

Static /dynamic

Hysteresis	%	< 0.1
Range of inversion	%	< 0.05
Response sensitivity	%	< 0.05
Manufacturing tolerance q_{Vmax}	%	< 10
Temperature drift (temperature range 20 °C ... 80 °C)		Zero shift < 0.25% with $\Delta\theta = 10$ K
Pressure drift	%/100 bar	Zero shift < 0.15
Zero compensation		ex plant $\pm 1\%$

Technical data

(for applications outside these values, please consult us!)

Electrical, integrated electronics (OBE) – Interface "A1" and "F1"		
Relative duty cycle	%	100 (continuous operation)
Protection class according to EN 60529		IP 65 with mounted and locked plug-in connectors
Supply voltage	VDC	24
▶ Terminal A	VDC	min. 19 / max. 36
▶ Terminal B	VDC	0
Maximum admissible residual ripple	V _{pp}	2.5
Maximum power consumption	VA	40
Fuse protection, external	A _T	2.5 (time-lag)
Input, version "A1"		Differential amplifier, $R_i = 100 \text{ k}\Omega$
▶ Terminal D (U_E)	VDC	0 ... ± 10
▶ Terminal E	VDC	0
Input, version "F1"		Load, $R_{sh} = 200 \Omega$
▶ Terminal D (I_{D-E})	mA	4 ... 20
▶ Terminal E (I_{D-E})		Current loop I_{D-E} feedback
Maximum voltage of the differential inputs against 0 V		D → B; E → B (max. 18 V)
Test signal, version "A1"		LVDT
▶ Terminal F (U_{Test})	VDC	0 ... ± 10
▶ Terminal C		Reference 0 V
Test signal, version "F1"	mA	LVDT signal 4 ... 20 at external load 200 ... 500 Ω maximum
▶ Terminal F (I_{F-C})	mA	4 ... 20 output
▶ Terminal C (I_{F-C})		Current loop I_{F-C} feedback
Functional ground and screening		see pin assignment on page 9 (CE-compliant installation)
Adjustment		Calibrated in the plant, see valve characteristic curves page 11 ... 19

Electrical, integrated electronics (OBE) – Interface "L1"		
Relative duty cycle	%	100 (continuous operation)
Protection class according to EN 60529		IP 65 with mounted and locked plug-in connectors
Supply voltage		
▶ Valve amplifier	VDC	24
– Pin 2	VDC	min. 18 / max. 30
– Pin 5	VDC	0
▶ IO-Link interface	VDC	24
– Pin 1	VDC	min. 18 / max. 30
– Pin 3	VDC	0
Maximum current consumption		
▶ Valve amplifier	A	2
▶ IO-Link interface	mA	50
Maximum residual ripple	V _{pp}	1.3
Maximum current consumption	mA	50
Minimum process cycle time	ms	0.6
Bit rate COM3	kBaud (kbit/s)	230.4
Required master port class		Class B
Resolution		
▶ A/D transformer	bit	12 (110% valve opening)
▶ D/A transformer	bit	12 (110% valve opening)
Functional ground		provide via valve block
Adjustment		calibrated in the plant
Directive		IO-Link Interface and System Specification Version 1.1.2

Technical data

(for applications outside these values, please consult us!)

Electrical, integrated control electronics (OBE) - Interface "C6"		
Relative duty cycle	%	100 (continuous operation)
Protection class according to EN 60529		IP 65 with mounted and locked plug-in connectors
Supply voltage	VDC	24
▶ Terminal A	VDC	min. 19 / max. 36
▶ Terminal B	VDC	0
Maximum admissible residual ripple	Vpp	2.5
Maximum power consumption	VA	40
Fuse protection, external	A _T	2.5 (time-lag)
Input		Load, R _{sh} = 200 Ω
▶ Terminal D (I _{D-E})	mA	0 ... ±10
▶ Terminal E (I _{D-E})		Current loop I _{D-E} feedback
Test signal		LVDT signal 4 ... 20 mA on external load 200 ... 500 Ω maximum
▶ Terminal F (I _{F-C})	mA	4 ... 20
▶ Terminal B (I _{F-C})		Current loop I _{F-C} feedback
Functional ground and screening		see page 9 (EMC-compliant installation)
Adjustment		Calibrated in the plant, see valve characteristic curves page 11 ... 19

Electrical connections and assignment

Contact	Interface assignment		
	"A1" (6 + PE)	"F1" (6 + PE)	"C6" (6 + PE)
A	24 VDC supply voltage		
B	GND		GND, reference potential actual value/enable
C	Reference potential actual value	Reference potential actual value	Reference potential actual value/ command value Enable input 24 VDC (high ≥ 11 V, low ≤ 5 V)
D	Command value ± 10 V ($R_e > 100$ k Ω)	Command value 4 ... 20 mA ($R_e = 200$ Ω)	Command value ± 10 mA ($R_e = 200$ Ω)
E	Reference potential command value	Reference potential command value	Reference potential command value
F	Actual value ± 10 V ($R_i \approx 1$ k Ω)	Actual value 4 ... 20 mA (Load max. 500 Ω)	Actual value 4 ... 20 mA (Load max. 500 Ω)
FE	Functional ground (directly connected to the valve housing)		

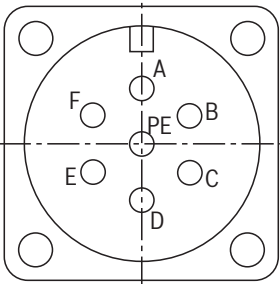

Command value	<ul style="list-style-type: none"> ▶ Positive command value (0 ... 10 V or 12 ... 20 mA) at D and reference potential at E cause flow from P → A and B → T. ▶ Negative command value (0 ... -10 V or 12 ... 4 mA) at D and reference potential at E cause flow from P → B and A → T.
Connection cable	<ul style="list-style-type: none"> ▶ Up to 20 m cable length type LiYCY 7 x 0.75 mm² ▶ Up to 40 m cable length type LiYCY 7 x 1.0 mm² ▶ EMC-compliant installation: <ul style="list-style-type: none"> - Apply screening to both line ends - Use metal mating connector (see page 21) ▶ Alternatively up to 30 m cable length admissible <ul style="list-style-type: none"> - Apply screening on supply side - Plastic mating connector (see page 21) can be used

Notice:

Mating connectors, separate order, see page 21 and data sheet 08006.

Connector pin assignment "L1" (M12-5, A-coded, class B)

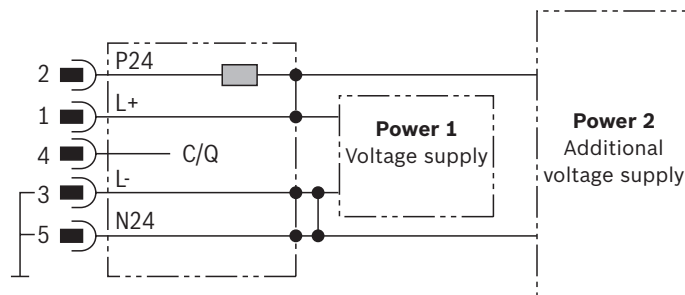
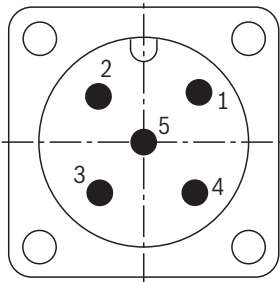

Notice:

- ▶ M12 sensor/actuator connection line, 5-pole; M12 connector/bush, A-coded, without shield, maximum cable length 20 m. Observe the voltage drop over the cable. Wire cross-section at least 0.34 mm².
- ▶ Mating connectors, separate order, see page 21 and data sheet 08006.
- ▶ Communication and parameter description see data sheet 29400-PA

Pin	Signal	Allocation interface L1
1	L+	Voltage supply IO-Link
2	P24	Voltage supply valve electronics and power part (current consumption 2 A)
3	L-	Reference potential pin 1 ¹⁾
4	C/Q	Data line IO-Link (SDCI)
5	N24	Reference potential pin 2 ¹⁾

¹⁾ Pin 3 and 5 are linked with each other in the valve electronics. The reference potentials L- and N24 of the two supply voltages must also be linked with each other on the power supply unit side.

Block diagram/controller function block

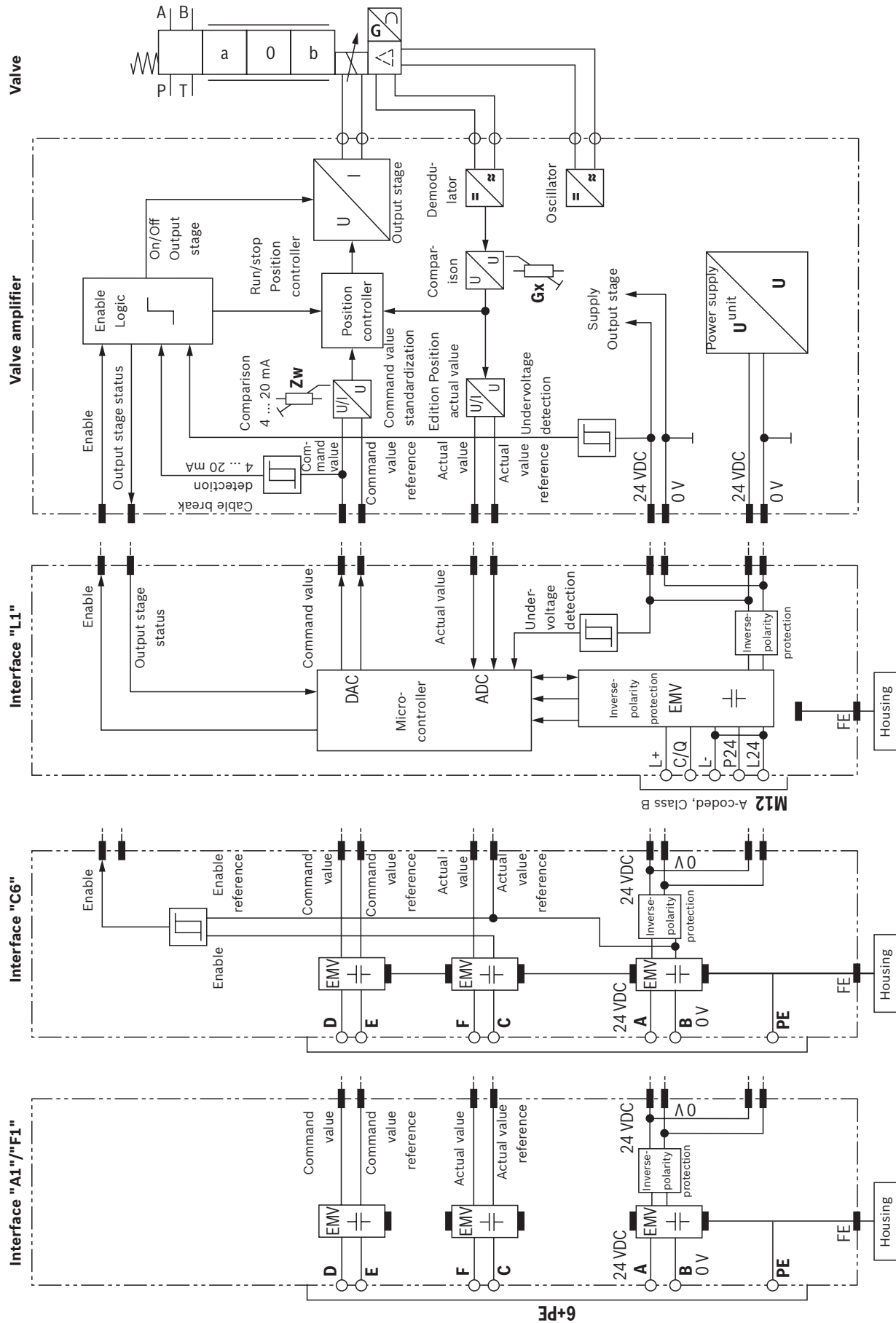

Characteristic curves: Flow characteristic "L"
 (measured with HLP46, $\vartheta_{oil} = 40 \pm 5 \text{ }^\circ\text{C}$; $\Delta p = 35 \text{ bar/control edge}$)

Flow/signal function

Symbol C, C3 and C4 – Version "04"

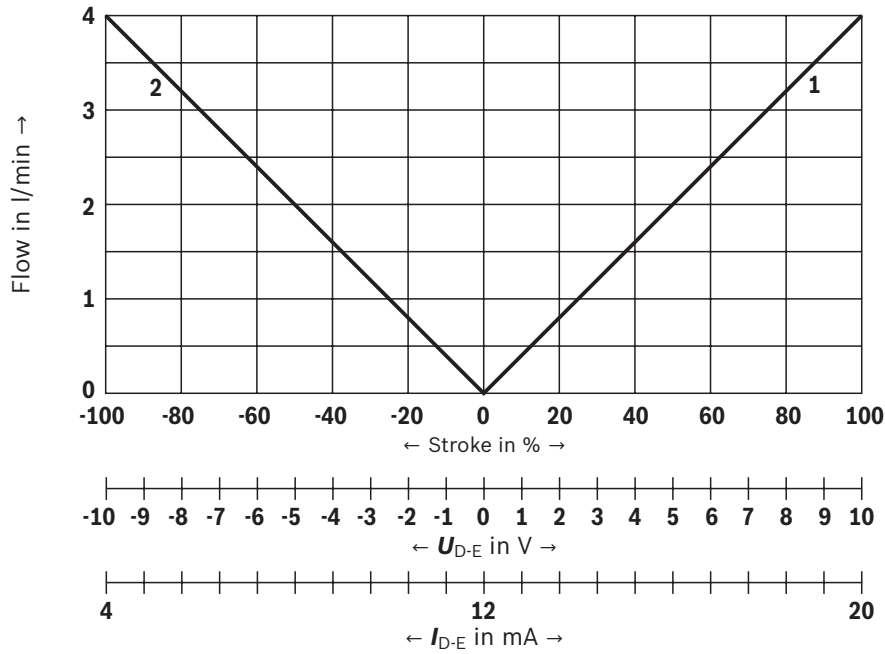

- 1 P-A; B-T
- 2 P-B; A-T

Symbol C, C3 and C4 – Version "12"

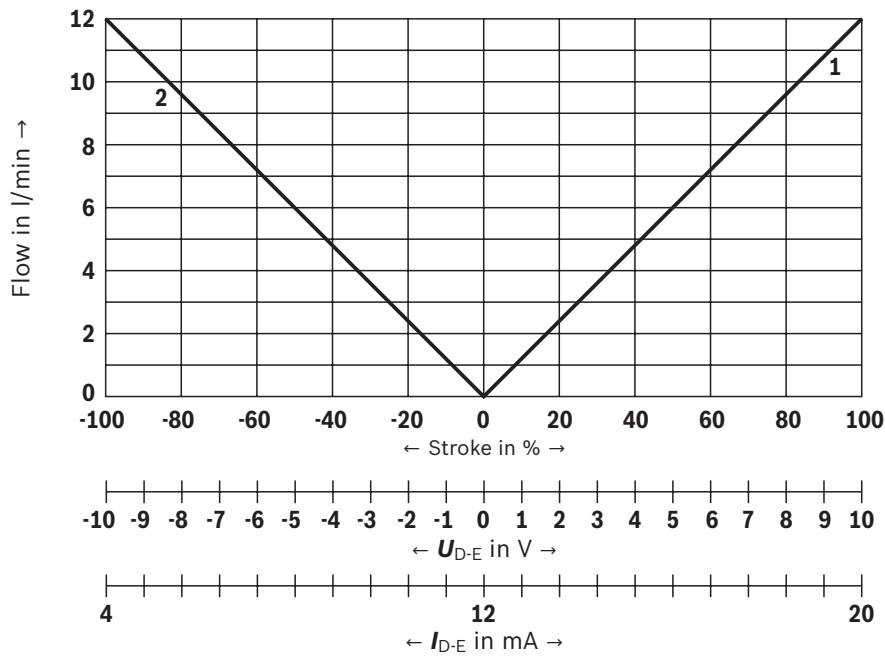

- 1 P-A; B-T
- 2 P-B; A-T

Characteristic curves: Flow characteristic "L"
 (measured with HLP46, $\vartheta_{oil} = 40 \pm 5 \text{ }^\circ\text{C}$; $\Delta p = 35 \text{ bar/control edge}$)

Flow/signal function

Symbol C, C3 and C4 – Version "24"

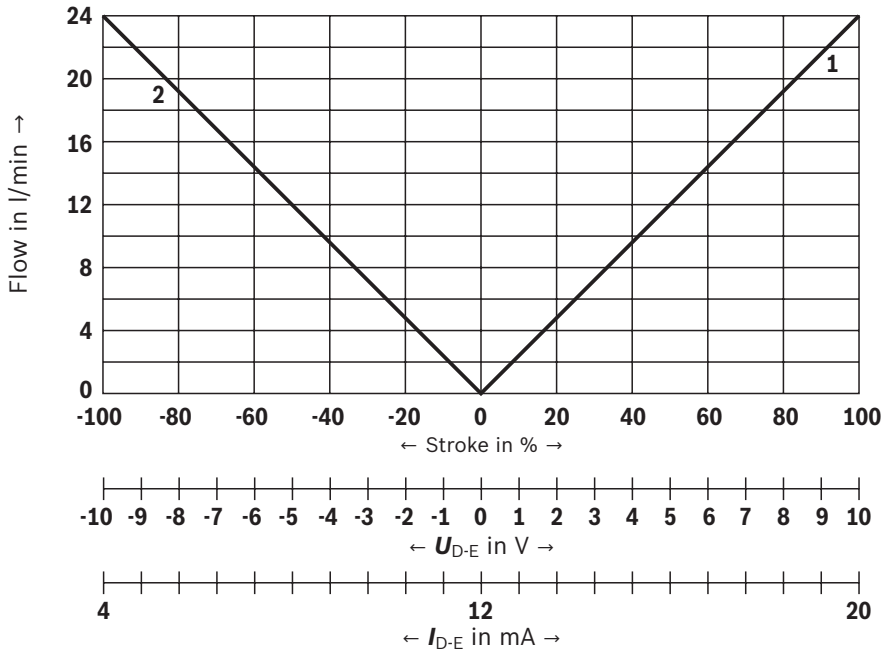

- 1 P-A; B-T
- 2 P-B; A-T

Symbol C, C3 and C4 – Version "40"

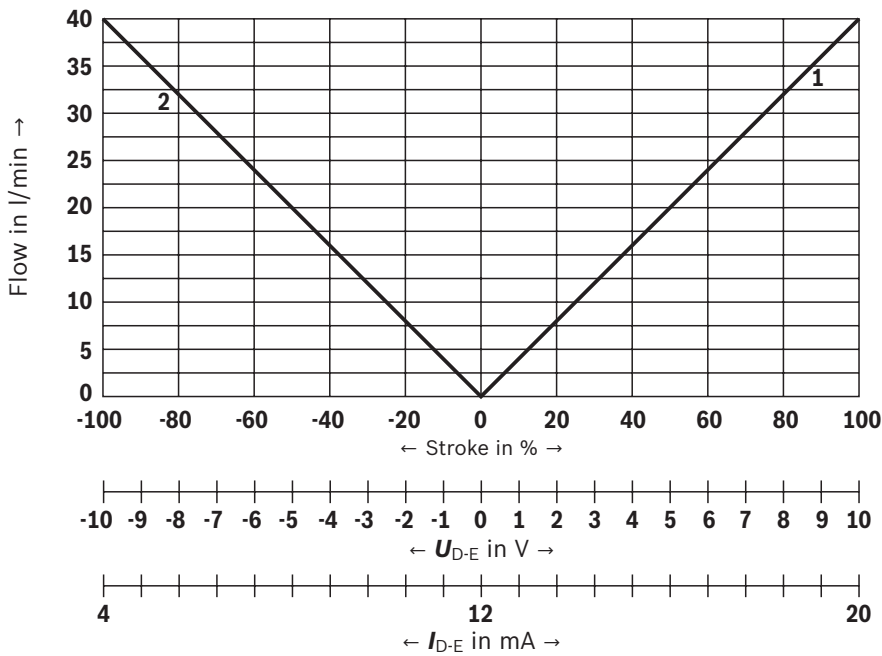

- 1 P-A; B-T
- 2 P-B; A-T

Characteristic curves: Flow characteristic "L"
 (measured with HLP46, $\vartheta_{oil} = 40 \pm 5 \text{ }^\circ\text{C}$; $\Delta p = 35 \text{ bar/control edge}$)

Flow/signal function

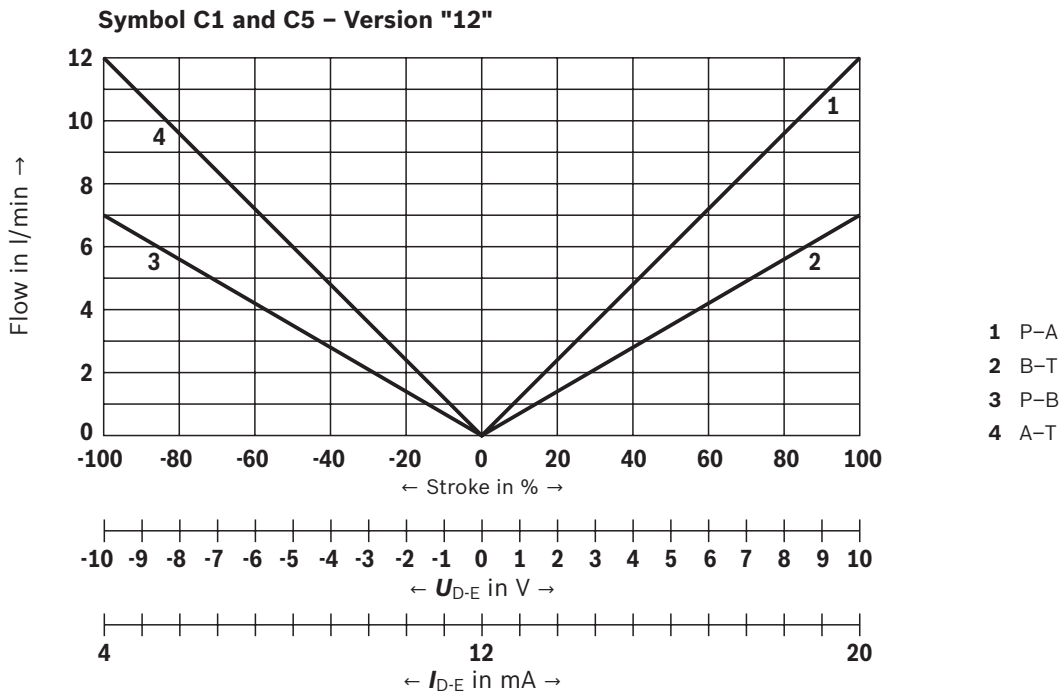
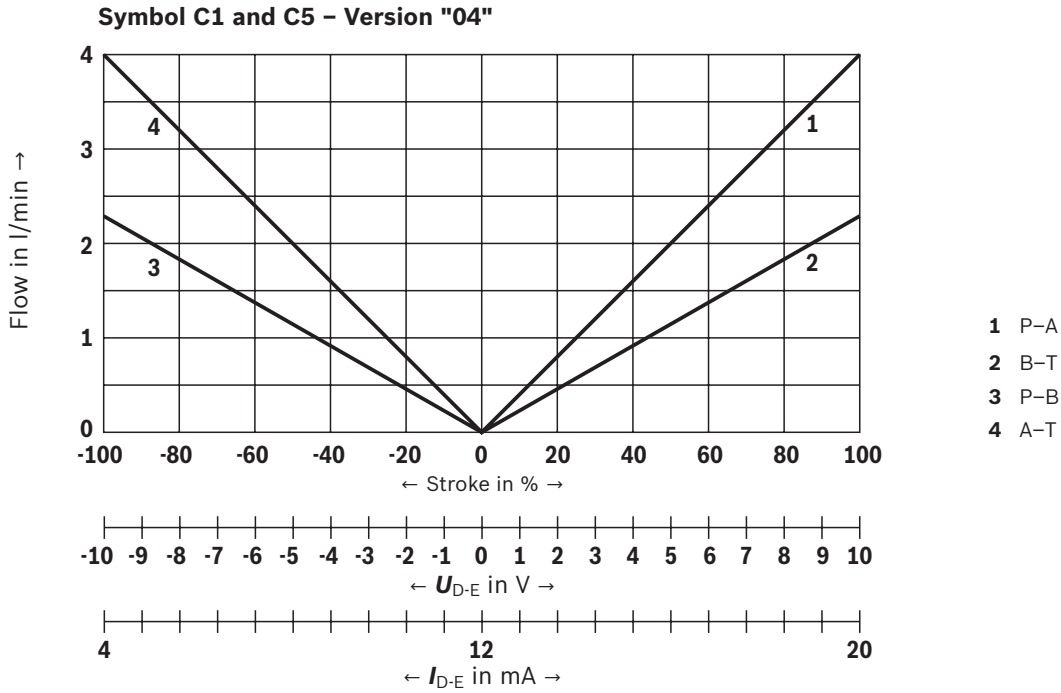

Characteristic curves: Flow characteristic "L"
 (measured with HLP46, $\vartheta_{oil} = 40 \pm 5 \text{ }^\circ\text{C}$; $\Delta p = 35 \text{ bar/control edge}$)

Flow/signal function

Symbol C1 and C5 – Version "24"

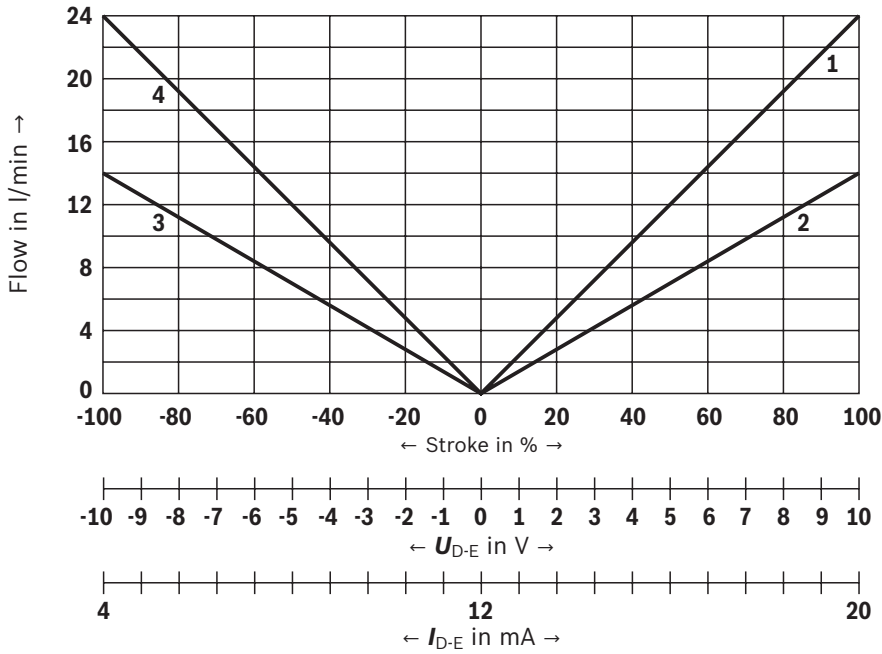

- 1 P-A
- 2 B-T
- 3 P-B
- 4 A-T

Symbol C1 and C5 – Version "40"

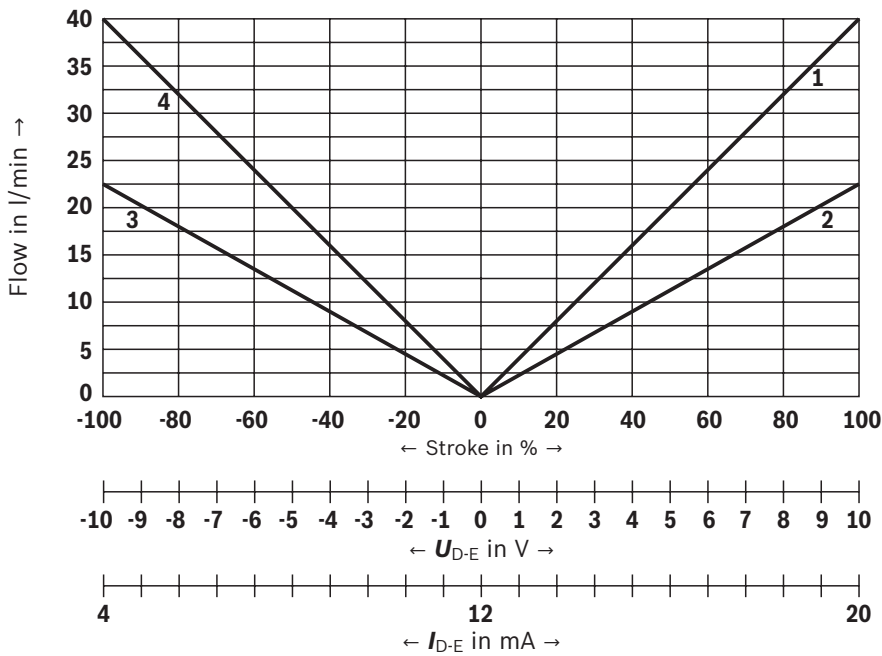

- 1 P-A
- 2 B-T
- 3 P-B
- 4 A-T

Characteristic curves: Flow characteristic "P"
 (measured with HLP46, $\vartheta_{oil} = 40 \pm 5 \text{ }^\circ\text{C}$; $\Delta p = 35 \text{ bar/control edge}$)

Flow/signal function

Symbol C, C3 and C4 – Version "04"

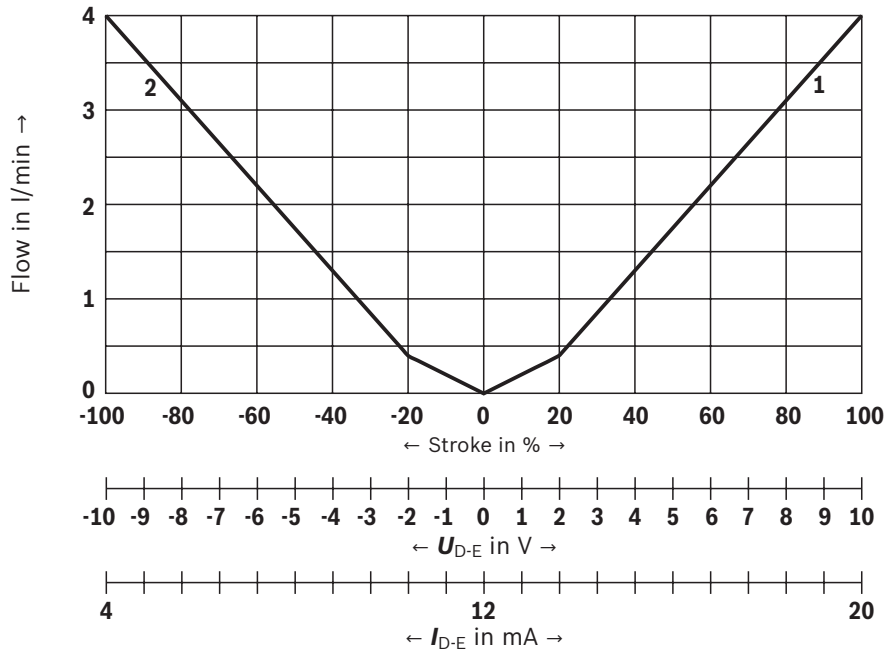

- 1 P-A; B-T
- 2 P-B; A-T

Symbol C, C3 and C4 – Version "15"

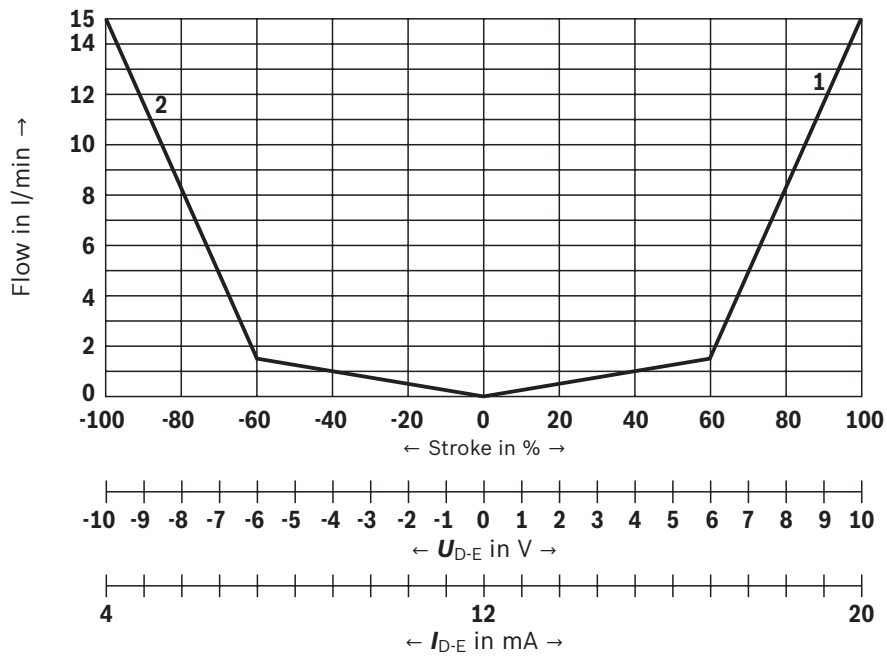

- 1 P-A; B-T
- 2 P-B; A-T

Characteristic curves: Flow characteristic "P"
 (measured with HLP46, $\vartheta_{oil} = 40 \pm 5 \text{ }^\circ\text{C}$; $\Delta p = 35 \text{ bar/control edge}$)

Flow/signal function

Symbol C, C3 and C4 – Version "25"

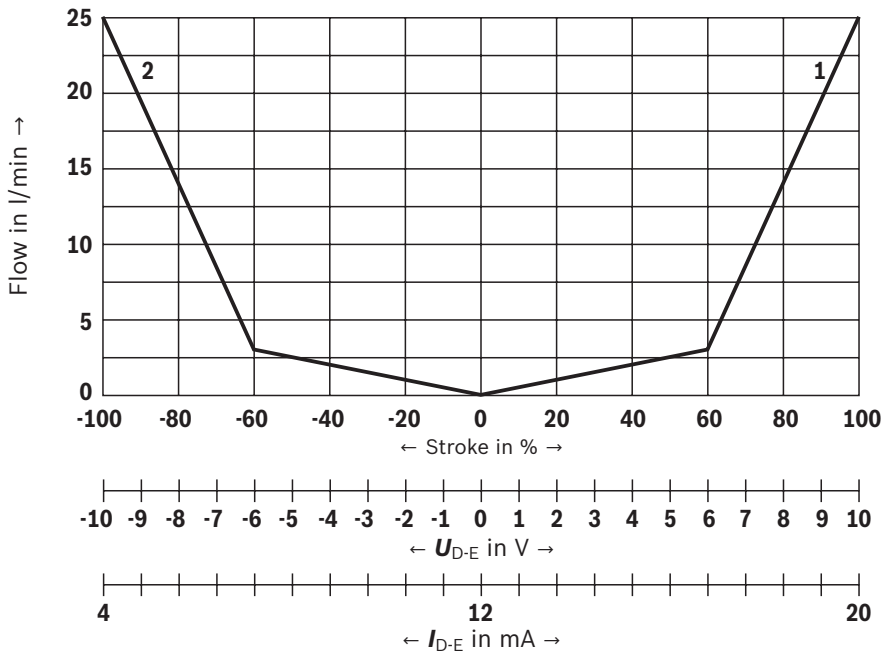

- 1 P-A; B-T
- 2 P-B; A-T

Symbol C, C3 and C4 – Version "40"

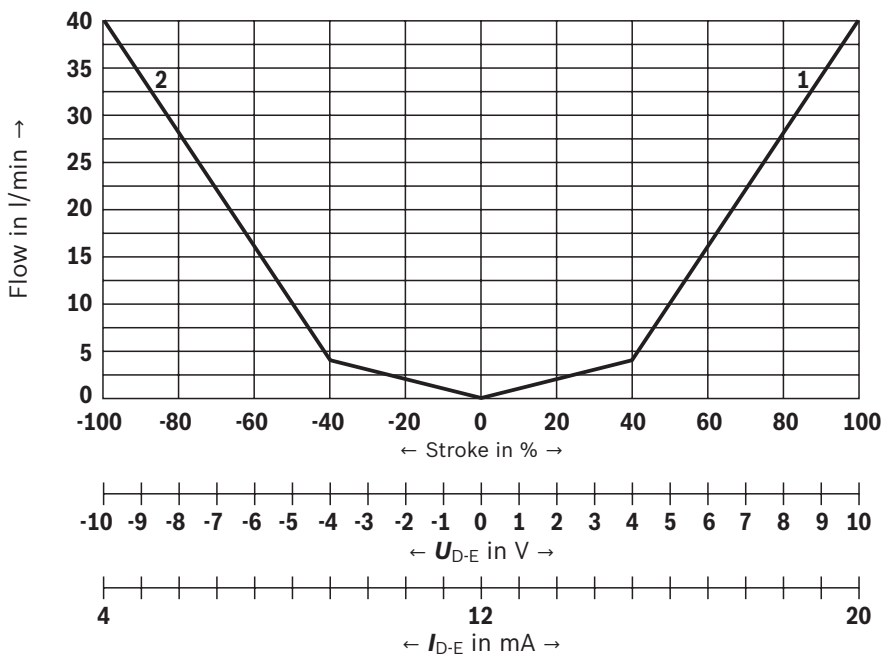

- 1 P-A; B-T
- 2 P-B; A-T

Characteristic curves: Flow characteristic "P"
 (measured with HLP46, $\vartheta_{oil} = 40 \pm 5 \text{ }^\circ\text{C}$; $\Delta p = 35 \text{ bar/control edge}$)

Flow/signal function

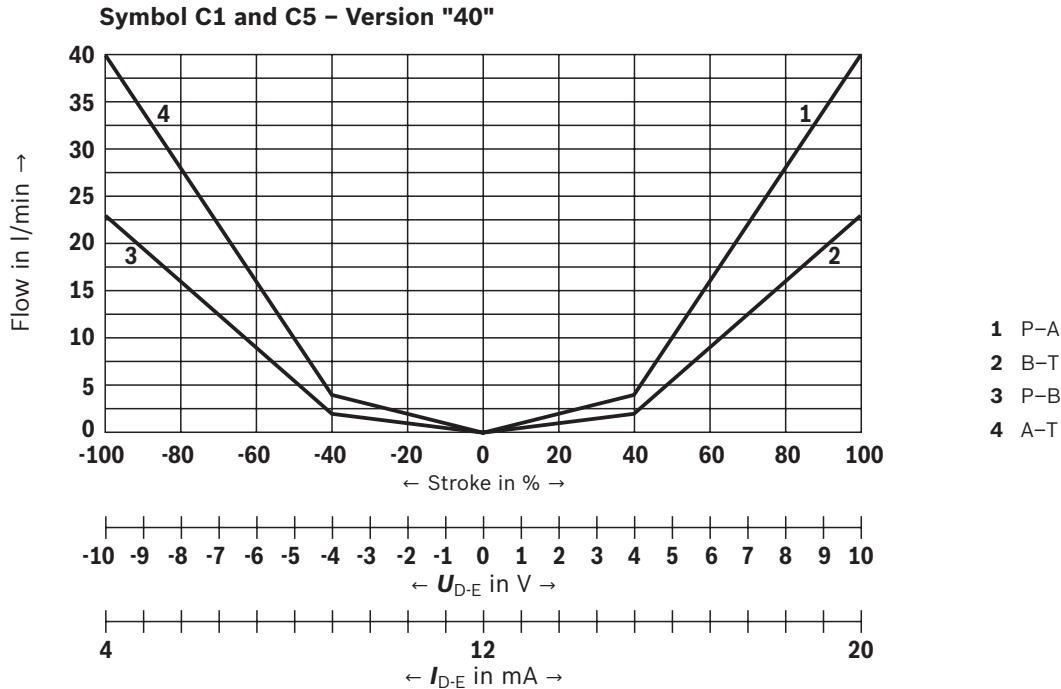

Fail-safe position: Flow/leakage flow

		Rated flow at $\Delta p = 35 \text{ bar/control edge}$		l/min	4	12	15	24/25	40
C		Flow at $\Delta p = 35 \text{ bar/control edge}$		l/min	4	10	13	18	20
C3, C5		Leakage flow at 100 bar	P \rightarrow A	cm ³ /min	50				
			P \rightarrow B	cm ³ /min	70				
		Flow at $\Delta p = 35 \text{ bar}$	A \rightarrow T	l/min	10 ... 20				
			B \rightarrow T	l/min	7 ... 20				
C4, C1		Leakage flow at 100 bar	P \rightarrow A	cm ³ /min	50				
			P \rightarrow B	cm ³ /min	70				
			A \rightarrow T	cm ³ /min	70				
			B \rightarrow T	cm ³ /min	50				
	Fail-safe	$p = 0 \text{ bar} \Rightarrow 7 \text{ ms}$	Internal shut-off in case of the following errors: ▶ Drop of supply voltage $U_B \leq 15 \text{ V}$ and restarting at $U_B \geq 17.5 \text{ V}$. ▶ Only at interface "F1": - Falling below the minimum current command value of 2 mA (includes cable break of the command value line (current loop)) ▶ Only at interface "L1": - Enable inactive, communication interruption (watchdog) - In case of internal IO-Link error						
		$p = 100 \text{ bar} \Rightarrow 10 \text{ ms}$							

Characteristic curves

(measured with HLP46, $\vartheta_{oil} = 40 \pm 5 \text{ }^\circ\text{C}$)

Pressure/signal characteristic curve

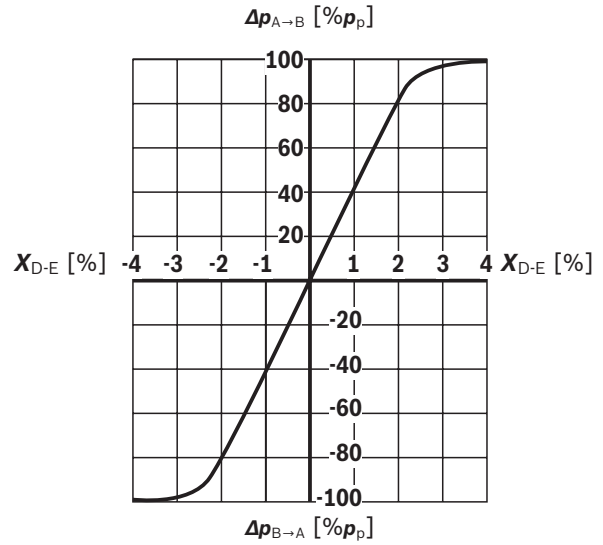
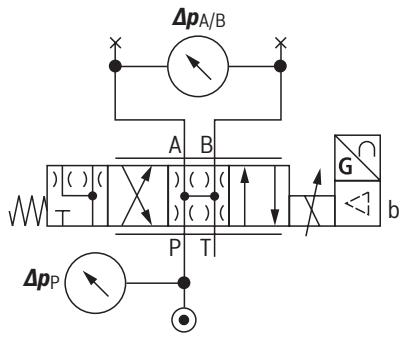

Transition function with stepped electric input signals

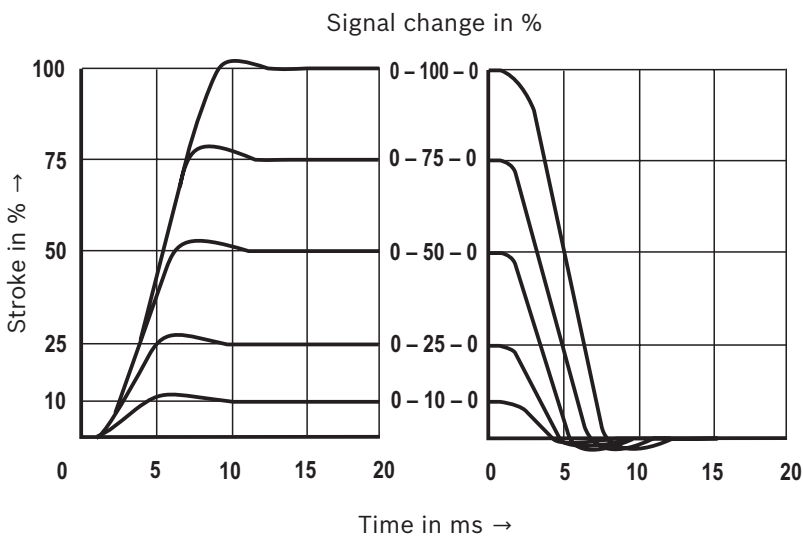

Characteristic curves

(measured with HLP46, $\vartheta_{oil} = 40 \pm 5 \text{ }^\circ\text{C}$)

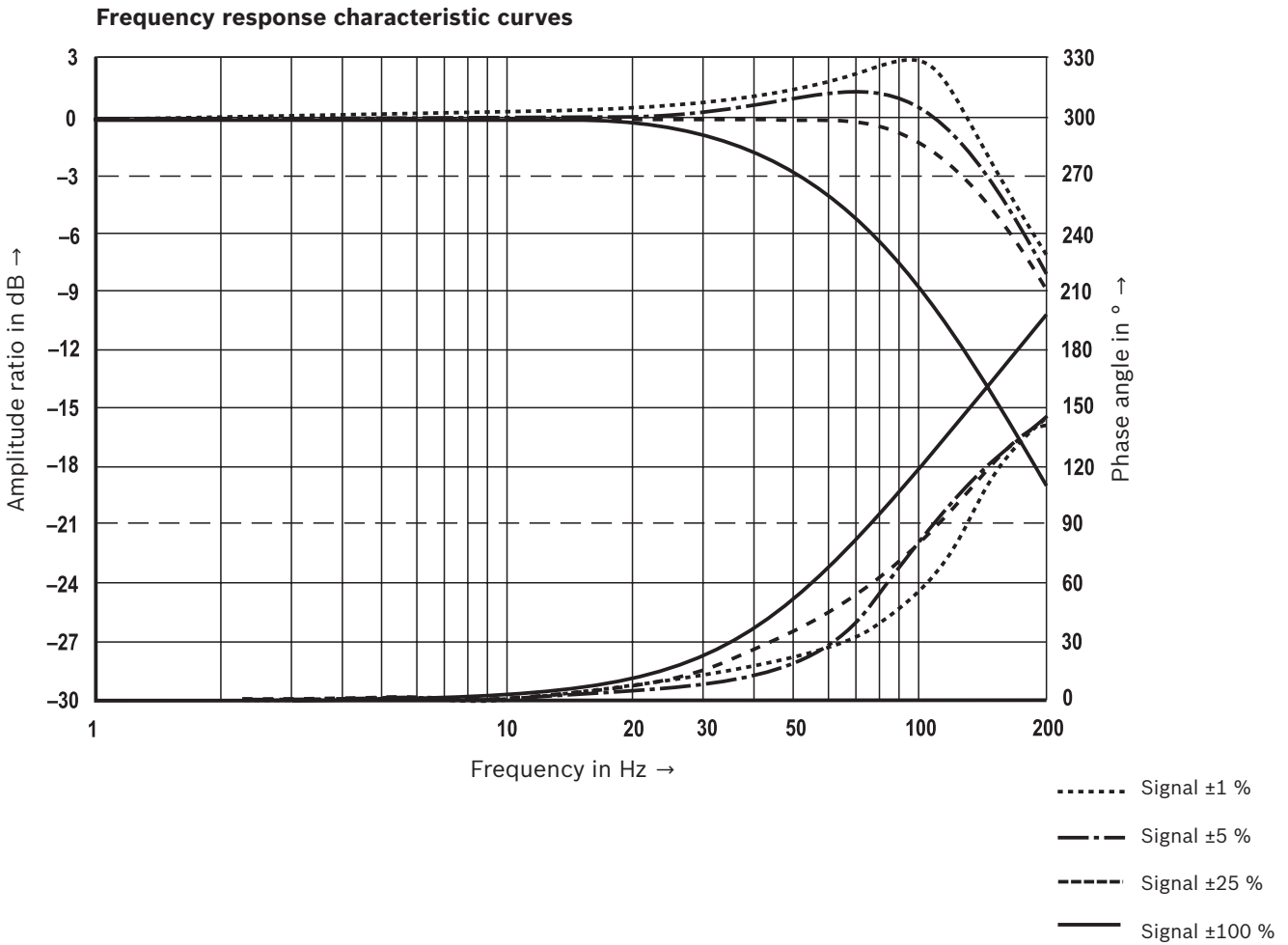

Flow/load function with maximum valve opening

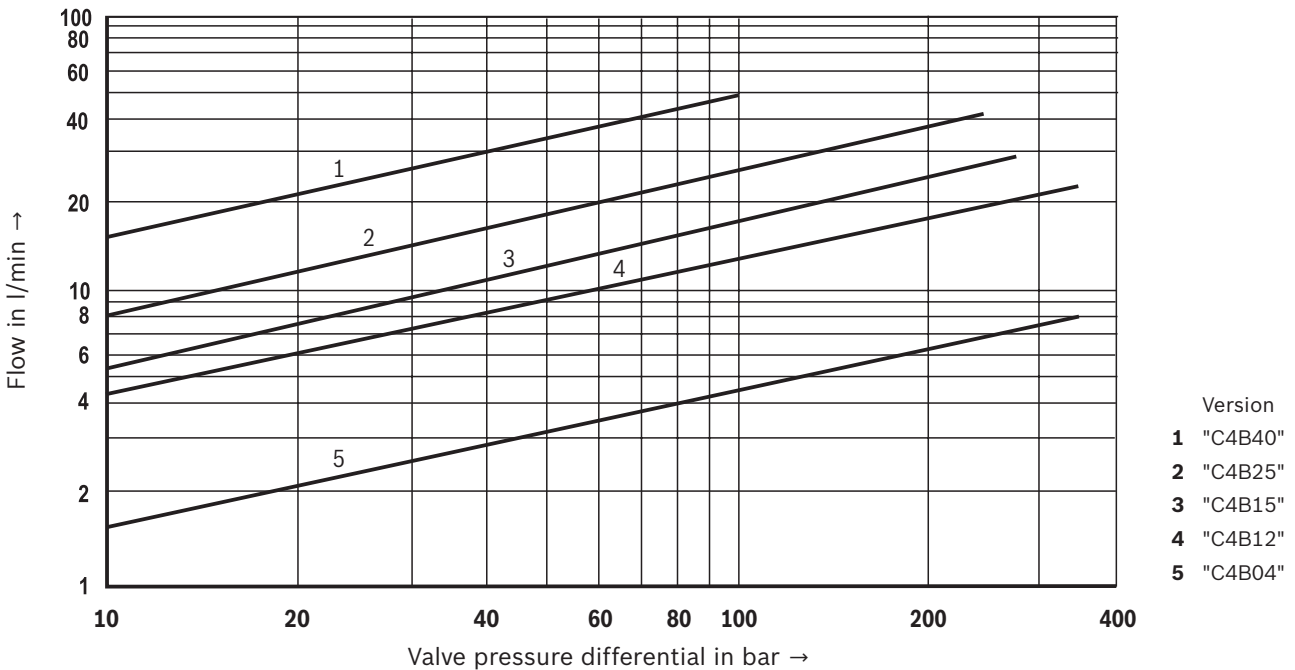

Dimensions

(dimensions in mm)

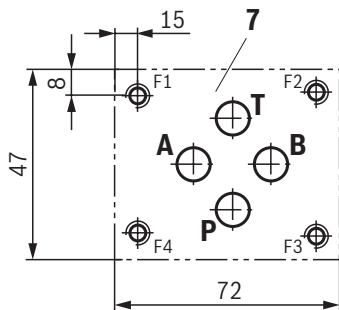
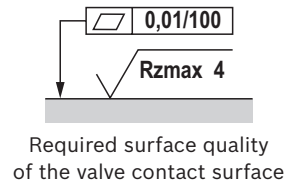
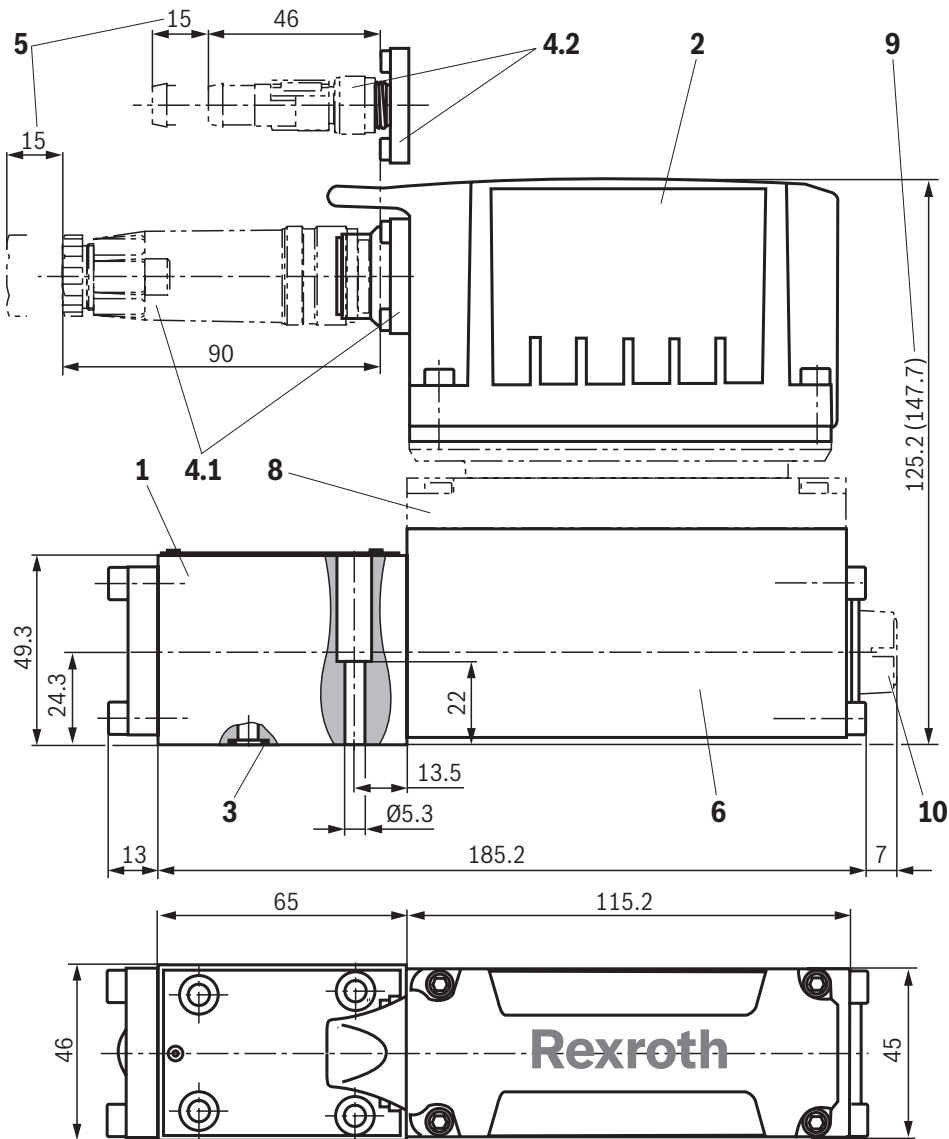

- 1 Valve housing
- 2 Integrated electronics
- 3 Identical seal rings for ports P, A, B, T
- 4.1 Mating connectors with version "A1", "F1" and "C6", separate order, see page 21 data sheet 08006
- 4.2 Mating connectors with version "L1", separate order, see page 21 data sheet 08006
- 5 Space required to remove the mating connector
- 6 Control solenoid with position transducer
- 7 Machined valve contact surface, porting pattern according to ISO 4401-03-02-0-05
Deviating from the standard: Ports P, A, B, T Ø8 mm
Minimum screw-in depth:
▶ Ferrous metal 1.5 x Ø
▶ Non-ferrous 2 x Ø
- 8 Damping plate "D"
- 9 Dimension in () for version with damping plate "D"
- 10 Electronics protection membrane "-967"

Notice:

The dimensions are nominal dimensions which are subject to tolerances.

Dimensions

Valve mounting screws (separate order)

4 hexagon socket head cap screws	Material number
ISO 4762 - M5 x 30 - 10.9-CM-Fe-ZnNi-5-Cn-T0-H-B Tightening torque $M_A = 7 \text{ Nm} \pm 10 \%$	R913048086
or	
ISO 4762 - M5 x 30 - 10.9 Tightening torque $M_A = 8.9 \text{ Nm} \pm 10 \%$	Not included in the Rexroth delivery range
or	
ASME B18.3 - 10-24 UNC x 1 1/4" - ASTM-A574 Tightening torque $M_A = 8.0 \text{ Nm} [5.9 \text{ ft-lbs}] \pm 10 \%$	Not included in the Rexroth delivery range



Notice:

The tightening torque of the hexagon socket head cap screws refers to the maximum operating pressure.

Subplates (separate order) with porting pattern according to ISO 4401-03-02-0-05 see data sheet 45100.

Accessories (separate order)

Valves with integrated electronics

Mating connectors 6-pole + PE	Design	Version	Material number	Data sheet
For the connection of valves with integrated electronics, round connector 6+PE, line cross-section 0.5 ... 1.5 mm ²	straight	Metal	R900223890	08006
	straight	Plastic	R900021267	08006
	angled	Plastic	R900217845	–

Cable sets 6-pole + PE	Length in m	Material number	Data sheet
For the connection of valves with integrated electronics, round connector 6+PE, straight connector, shielded, potted-in mating connector, line cross-section 0.75 mm ²	3.0	R901420483	08006
	5.0	R901420491	08006
	10.0	R901420496	08006
	20.0	R901448068	–

Test and service devices

	Material number	Data sheet
Service case with test device for proportional servo valves with integrated electronics (OBE)	R901049737	29685

IO-Link gateways

Designation	Description	Material number
S67E-PN-IOL8-DI4-M12-6P	IndraControl S67E PROFINET device in the plastic housing 8 IO-Link ports (4 x class A and 4 x class B), 4 digital inputs, 24 VDC, M12 quick connection technology	R911174436
S67E-S3-IOL8-DI4-M12-6P	IndraControl S67E Sercos device in the plastic housing 8 IO-Link ports (4 x class A and 4 x class B), 4 digital inputs, 24 VDC, M12 quick connection technology	R911174437

Further information

- ▶ Hydraulic valves for industrial applications Data sheet 07600-B
- ▶ Subplates Data sheet 45100
- ▶ Hydraulic fluids on mineral oil basis Data sheet 90220
- ▶ Environmentally compatible hydraulic fluids Data sheet 90221
- ▶ Flame-resistant, water-free hydraulic fluids Data sheet 90222
- ▶ Flame-resistant hydraulic fluids - containing water (HFAE, HFAS, HFB, HFC) Data sheet 90223
- ▶ Reliability characteristics according to EN ISO 13849 Data sheet 08012
- ▶ Hexagon socket head cap screw, metric/UNC Data sheet 08936
- ▶ Installation, commissioning and maintenance of servo valves and high-response valves Data sheet 07700
- ▶ Assembly, commissioning and maintenance of hydraulic systems Data sheet 07900
- ▶ Directional control valves, direct operated, with electrical position feedback and IO-Link interface Data sheet 29400-PA
- ▶ Selection of filters www.boschrexroth.com/filter
- ▶ Information on available spare parts www.boschrexroth.com/spc

Bosch Rexroth AG
Industrial Hydraulics
Zum Eisengießer 1
97816 Lohr am Main, Germany
Phone +49 (0) 93 52/40 30 20
my.support@boschrexroth.de
www.boschrexroth.de

© All rights reserved to Bosch Rexroth AG, also regarding any disposal, exploitation, reproduction, editing, distribution, as well as in the event of applications for industrial property rights.
The data specified above only serve to describe the product. No statements concerning a certain condition or suitability for a certain application can be derived from our information. The information given does not release the user from the obligation of own judgment and verification.
Please note that our products are subject to a natural process of wear and aging.

Notes

Bosch Rexroth AG
Industrial Hydraulics
Zum Eisengießer 1
97816 Lohr am Main, Germany
Phone +49 (0) 93 52/40 30 20
my.support@boschrexroth.de
www.boschrexroth.de

© All rights reserved to Bosch Rexroth AG, also regarding any disposal, exploitation, reproduction, editing, distribution, as well as in the event of applications for industrial property rights.
The data specified above only serve to describe the product. No statements concerning a certain condition or suitability for a certain application can be derived from our information. The information given does not release the user from the obligation of own judgment and verification.
Please note that our products are subject to a natural process of wear and aging.

Notes

Bosch Rexroth AG
Industrial Hydraulics
Zum Eisengießer 1
97816 Lohr am Main, Germany
Phone +49 (0) 93 52/40 30 20
my.support@boschrexroth.de
www.boschrexroth.de

© All rights reserved to Bosch Rexroth AG, also regarding any disposal, exploitation, reproduction, editing, distribution, as well as in the event of applications for industrial property rights.
The data specified above only serve to describe the product. No statements concerning a certain condition or suitability for a certain application can be derived from our information. The information given does not release the user from the obligation of own judgment and verification.
Please note that our products are subject to a natural process of wear and aging.