

The Compax3F is a part of the servo drive family of Parker Hannifin. It is especially designed for the requirements of electrohydraulic systems and in particular for position and force control of electrohydraulic axis.

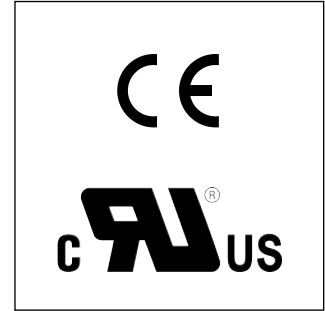

**Attention:**  
 For application support and customized software, please contact your local Parker representative.

**Large drive range**

- Valves:
  - Proportional direction control valves
  - Proportional pressure relief- and pressure reducing valves
  - Flow valves
- Drives:
  - Cylinders
  - Rotary drives
  - Motors

**Range of application**

- Closed loop position and force control of linear cylinders and rotary drives
- Switching between position and force control
- Synchronous run with up to 64 axes

**Typical applications**

- Feeder axis
- Position and force control of press cylinders in material forming machines
- Roller clearance control in roller presses
- Die casting machines
- Custom-designed software packages on request

**Ordering Code**

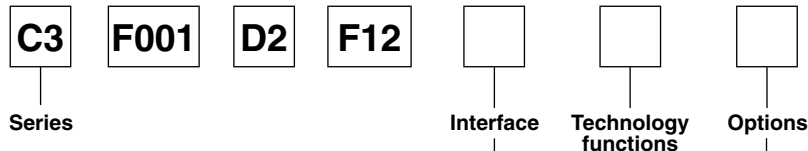

Code	Interface	T11	T30	T40
I11	Digital inputs/outputs		•	•
I12	Digital inputs/outputs	•		
I20	Profibus DP V0/V1/V2 (12 Mbit/s)	•	•	•
I21	CANopen		•	•
I22	DeviceNet		•	•
I30	PowerLink		•	•
I31	EtherCAT		•	•
I32	Profinet	•	•	•

Code	Options
M00	Standards
M10	Extension 12 digital I/Os & HEDA (motion bus)
M11	HEDA (motionbus)
M12	Extension 12 digital I/Os

Code	Technology functions
T11	Positioning/pressure and force control
T30	Programmable motion control according to IEC61131
T40	Electronic Cam

Connection set for Compax3F included in delivery.  
 Complete kit with mating plug connectors (X1, X2 and X3) for Compax3 connectors, special shield connecting terminal and snap-on foot for mounting rail

Function	Motion control with motion profiles. Suitable for position and force/pressure control
Housing / protection class	closed metal housing, isolation according to VDE 0160 / IP 20
Supply voltage [VDC]	21...27, ripple <1VSS
Current requirements [A]	0,8 for the device, digital outputs 100 mA each
Supported feedback-systems	<ul style="list-style-type: none"> <li>• Analog 0..20 mA, 4..20 mA, ±10 V</li> <li>• Start-Stop-Interface</li> <li>• SSI-Interface</li> <li>• EnDat2.2-Interface</li> <li>• 1VSS (max. 400 kHz) Interface, 13.5 Bit / Distance coding</li> <li>• TTL (RS422) (max. 5 MHz), internal post-quadrature resolution</li> </ul>
Set point generator	<ul style="list-style-type: none"> <li>• Jerk-limited ramps</li> <li>• Travel data in increments, mm, inches or variable by scale factor</li> <li>• Specification of speed, acceleration, delay and jerk factor</li> <li>• Force/pressure inputs in N, psi, etc. variable by scale factor</li> </ul>
Monitoring functions	<ul style="list-style-type: none"> <li>• Power/auxiliary supply range</li> <li>• Following error monitoring</li> <li>• Hard- and software switches</li> </ul>
Inputs and Outputs	<ul style="list-style-type: none"> <li>• 8 control inputs: 24 VDC / 10 kOhm</li> <li>• 4 control outputs Active HIGH / short-circuit protected / 24 V / 100 mA</li> <li>• 4 analog current input (14 Bit)</li> <li>• 2 analog voltage input (14 Bit)</li> <li>• 4 analog outputs (16 Bit, current or voltage) switchable in pairs</li> </ul>
RS232 / RS485 (switchable) RS232:	<ul style="list-style-type: none"> <li>• 115200 Baud</li> <li>• Word length 8 bits, 1 start bit, 1 stop bit</li> <li>• Hardware handshake XON, XOFF</li> </ul>
RS485 (2 or 4-wire):	<ul style="list-style-type: none"> <li>• 9600, 19200, 38400, 57600 or 115200 Baud</li> <li>• Word length 7/8 Bit, 1 Start-, 1 Stop bit</li> <li>• Parity (switchable) even/odd</li> </ul>
Bus systems	<ul style="list-style-type: none"> <li>• Profibus DP V0-V2 (I20), 12 Mbit/s, PROFIdrive-Profil Drive technology</li> <li>• CANopen (CiADS402) (I21)</li> <li>• DeviceNet (I22)</li> <li>• PowerLink (I30)</li> <li>• EtherCAT (I31)</li> <li>• Profinet (I32)</li> </ul>
CE compliance	<ul style="list-style-type: none"> <li>• EMC interference emission/limit values for industrial utilization according to EN61 800-3 first environment (commercial and residential area), class A via integrated mains filter for up to 10m cable length, otherwise with external mains filter</li> <li>• EMC immunity/limit values for industrial utilization according to EN61 800-3</li> </ul>
Insulation requirements	<ul style="list-style-type: none"> <li>• Protection class I according to EN 50178 (VDE 0160 part 1)</li> <li>• Contact protection: according to DIN VDE 0106, part 100</li> <li>• Overvoltage: Voltage class III according to HD 625 (VDE 0110-1)</li> <li>• Degree of contamination 2 according to HD 625 (VDE 0110 part 1) and EN 50178 (VDE 0160 part 1)</li> </ul>
Environmental conditions	
General environmental conditions acc. to EN 60 721-3-1 to 3-3	<ul style="list-style-type: none"> <li>• Climate (temperature / humidity / barometric pressure)</li> <li>• Class 3K3</li> </ul>
Permissible ambient temperature	<ul style="list-style-type: none"> <li>• Operation: 0 to +45 °C class 3K3</li> <li>• Storage: -25 to +70 °C class 2K3</li> <li>• Transport: -25 to +70 °C class 2K3</li> </ul>
Tolerated humidity: non condensing	<ul style="list-style-type: none"> <li>• Operation: ≤ 85 % class 2K3</li> <li>• Storage: ≤ 95 % class 3K3 (relative humidity)</li> <li>• Transport: ≤ 95 % class 2K3</li> </ul>
Elevation of operating site: ≤1000 m above sea level for 100 % load ratings	<ul style="list-style-type: none"> <li>• Please inquire for greater elevations</li> <li>• Protection class IP20 according EN 60 529</li> </ul>
EMC directives and harmonised EC norms	<ul style="list-style-type: none"> <li>• EC low voltage directive 73/23/EEC and RL 93/68/EEC: EN 50 178, General industrial safety norm Equipping electric power systems with electronic operating equipment HD 625, general electrical safety. Insulation principles for electrical operating equipment EN 60 204-1, Machinery norm, partly applied</li> <li>• EC-EMC directive 89/336/EEC: EN 61 800-3, EMC norm Product standard for variable speed drives EN 50 081-2 ... 50 082-2, EN 61 000-4-2 ...61 000-4-5</li> </ul>
UL-Certification	USL according to UL508 (listed) / CNL according to C22.2 No: 142-M1987 (listed) Certified: E-File-No: E198563
Weight [kg]	2.0

**Application example**

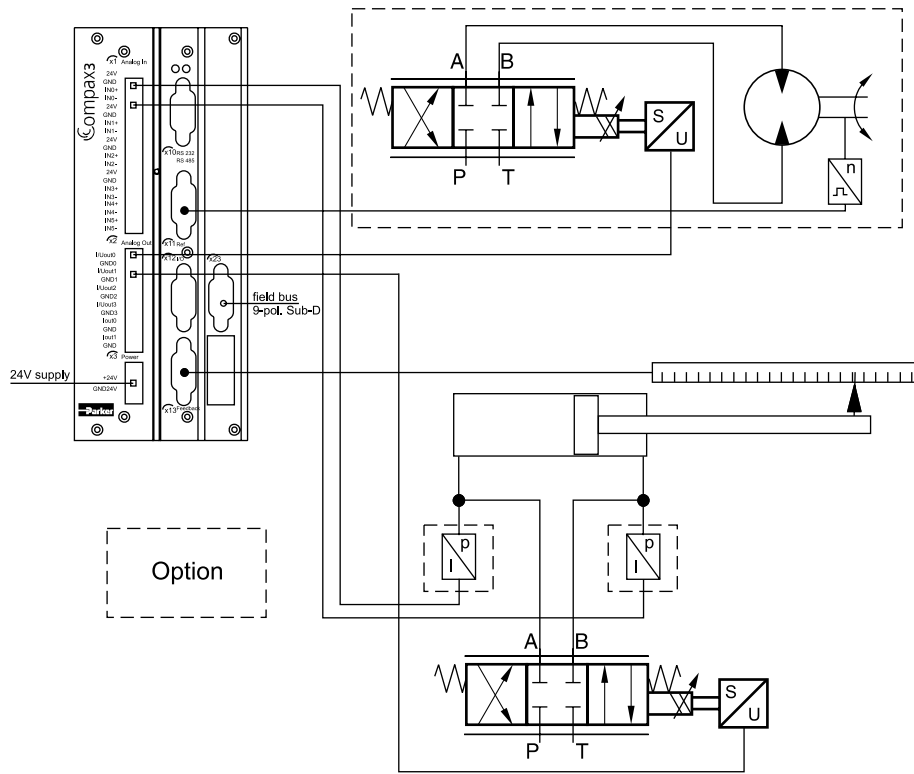

**Dimensions**

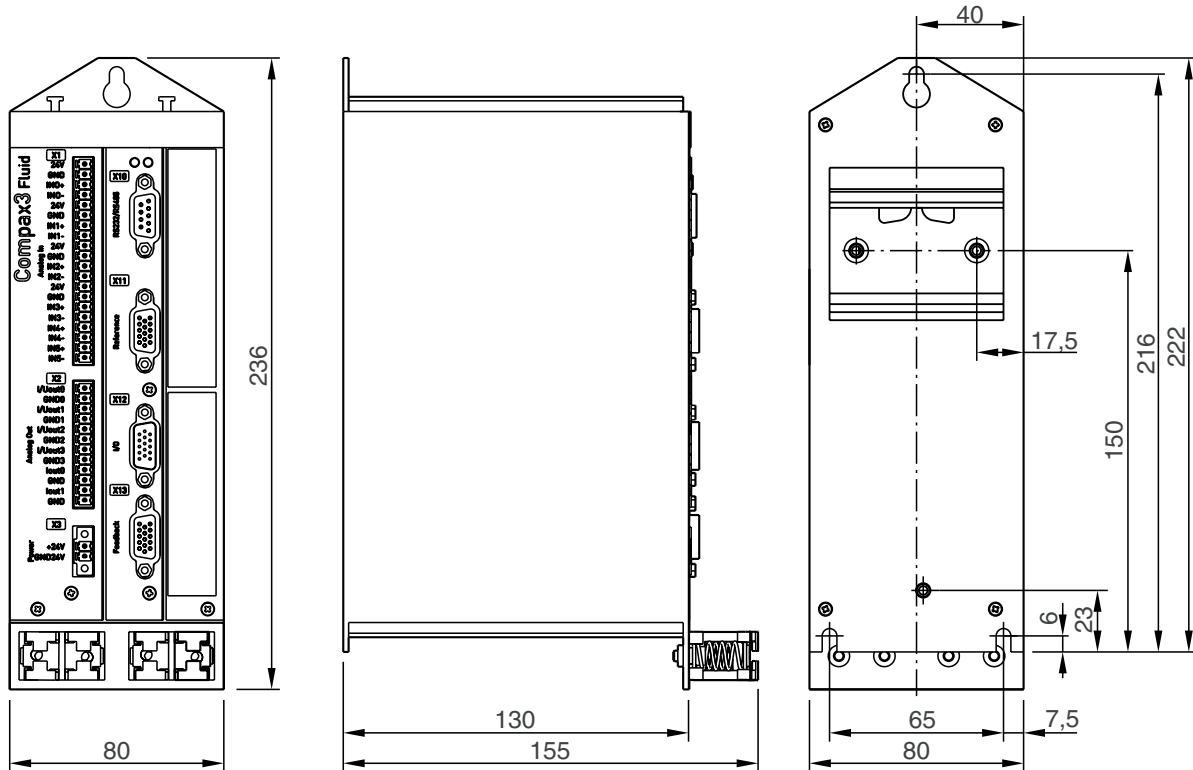

11

**Project development, commissioning and programming**

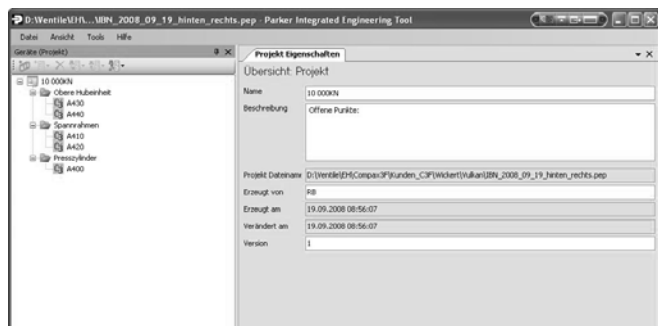

- **Compax3 ServoManager**
  - Intuitively understandable user interface
  - Wizard technology
  - Online help
  - Oscilloscope function
  - Optimized co-ordination of complete mechatronic systems
- **Valve and Drive manager**
  - All technical data of Parker valves, cylinders and drives available
  - Additionally support through the Compax3F Hydraulics-Manager by configuration of user defined valves and drives.

**Software download, free of charge:**  
[http://solutions.parker.com/c3\\_support](http://solutions.parker.com/c3_support)

**ActiveX plug-in for Integration with the Office environment**

- Office and industrial environments are constantly growing closer together.
- The use of ActiveX technology allows simple integration into Office application.

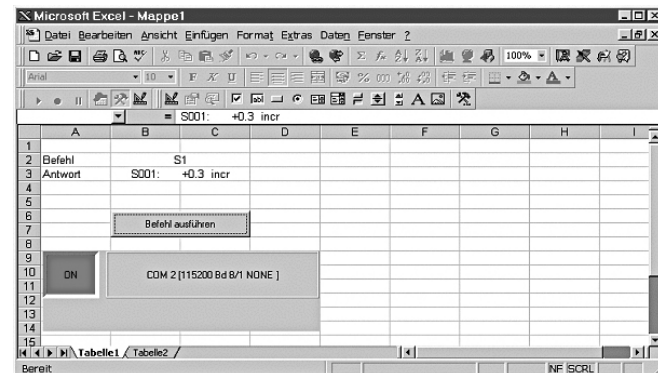

**Interface - Field bus**

- Profibus DP
- CANopen (CiADS402)
- DeviceNet
- PowerLink
- EtherCAT
- Profinet
- Address configurable via Dip switch

**International standards in programming**

- Programming system
  - CoDeSys
- Programming language
  - IEC61131-3
  - Function modules based on PLCopen

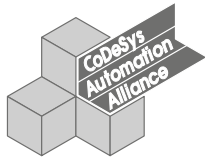

**Jerk-limited set point generation, resulting in**

- Gentle handling of the items being moved
- Increased service life of mechanical components
- Overshoot-free positioning
- Reduced excitation of mechanical resonance frequencies

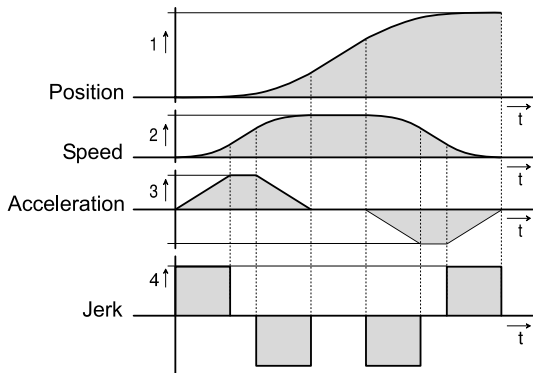

**Control**

**a) General**

- 2 control loops for each axis for combined position and force/pressure control

**b) Position control**

- Automatic controller design for position control
  - User-oriented optimization of parameters
- Feed forward control of speed and acceleration which results in:
  - Optimization of the response behaviour
  - Minimization of the following error

**c) Force/Pressure controller**

- PID controller with feed forward control of speed

**d) 2-axis synchronous run and hydraulic specific functions**

- Realization of many different circuit concepts with up to 4 proportional valves possible
- Linearization functions:
  - Consideration of the area of differential cylinders
  - Inverting of the valve set value
  - Compensation of the load pressure (additional pressure sensors necessary)
  - Correction of the nonlinear flow characteristic of the valve
  - Overlap compensation
  - Valve zero point correction
  - Valve set value filters
  - Valve set value limitation
  - All functions for each valve individually available
  - Automatic configuration by component selection in the Compax3 ServoManager

**e) Custom-designed software packages on request**

**Set up controller optimization**

- Compax3F HydraulicsManager
  - All necessary technical data of Parker valves and drives are available
  - additional supported
- Test movement for automatic controller attitude
- Optimization with integrated oscilloscope function
- Automatic pre-setting of the controller for position control possible

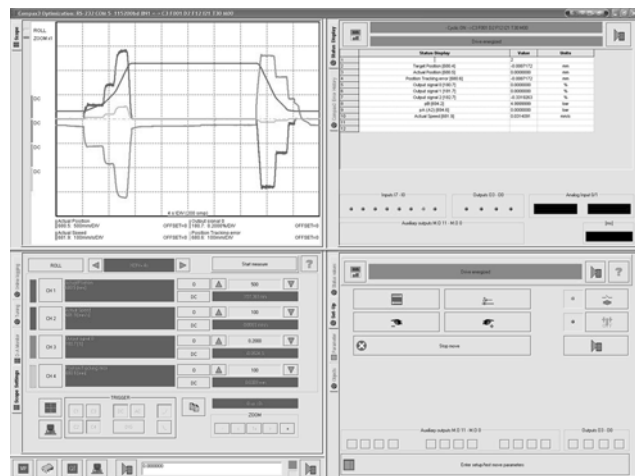

11

**Overview technology functions**

	T11	T30	T40
Set tables for up to 31 motion profiles	x		
Absolute or relative positioning	x	x	x
Force/pressure control	x	x	x
Electronic Gearbox	x	x	x
Dynamic positioning	x	x	x
Hydraulic specific control technology	x	x	x
Reg-related positioning	x	x	x
Programmable according to IEC61131-3		x	x
Programming system CoDeSys		x	x
Up to 6500 instructions		x	x
Recipe table with 288 variables		x	x
PLCopen		x	x
Mark synchronization			x
Cam switching mechanism			x
Cam profiles			x
Coupling and decoupling function			x
Custom-designed software packages*		O	O
Digital I/Os (RS232/485)	x	x	x
Profibus	O	O	O
CANopen		O	O
DeviceNet		O	O
Ethernet Powerlink		O	O
EtherCAT		O	O
Profinet	O	O	O

x = Standard

O = Optional

\* on request

**Benefits**

- No programming skills necessary
- Set table with various motion
- Full controller range available
- An ideal basis for many applications in high-performance motion automation

**Function range T11**

- Set tables for positioning, pressure and force control up to 31 motion profiles:
  - Absolute or relative positioning
  - Force/pressure control
  - Speed control
  - Electronic gearing
- Superimposed force and pressure control
- Controller switching between position and force/pressure control

**Extended Function range**

- Absolute force control
- Superimposed force and pressure control
- Controller switching between position and force/pressure control
- 2-axis synchronous

**Absolute or relative positioning**

A motion set defines a complete motion with all settable parameters

1. Target position
2. Travel speed
3. Maximum acceleration
4. Maximum deceleration
5. Maximum jerk

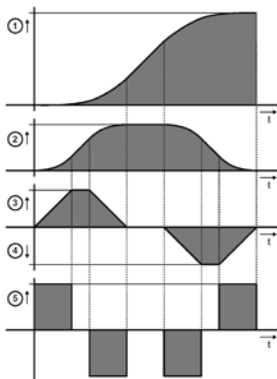

**Stop movement**

The Stop set interrupts the current motion set

**Reg-related positioning**

For registration mark-related positioning, 2 motions are defined:

- RegSearch: Search of an external signal, e.g. a registration mark on a product
- RegMove: The external signal interrupts the search movement and the second movement by an offset follows without transition
- Precision of the registration mark detection: <math><1\mu\text{s}</math>

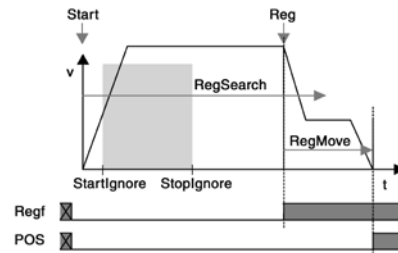

**Electronic Gearbox:**

Motion synchronized to a master axis with any transmission ratio. The position of a master axis can be detected via:

- $\pm 10$  V analog input
- Step/direction command Input
- the encoder input or
- HEDA, with Compax3 Master

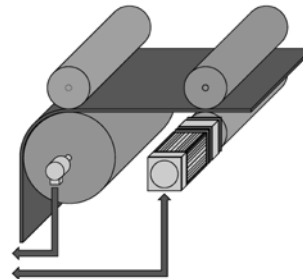

**Dynamic positioning**

A new motion profile can be selected during a positioning sequence - a smooth transition takes place.

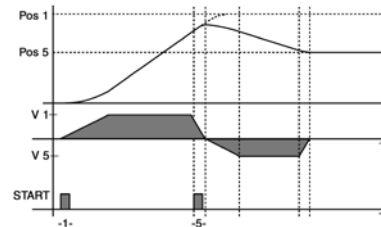

11

**General**

Due to its high flexibility and efficiency the Compax3 motion control according to PLCopen is for most applications the optimal basis for decentralized motion control.

**Positioning with function modules based on PLCopen**

- Programmable based on IEC61131-3
- Programming system: CoDeSys
- Up to 6500 instructions
- 500 16-bit variables / 150 32-bit variables
- Recipe table with 288 variables
- 3 16-bit saved variables (power failure protected) / 3 32-bit saved variables (power failure protected)
- PLCopen-function modules:
  - Positioning: absolute, relative, additive and continuous
  - Machine zero
  - Stop, energizing the power stage, quit
  - Position, device status, reading axis error
  - Electronic gearbox (Mc\_GearIn)
- IEC61131-3-standard modules:
  - Up to 8 timers (TON, TOF, TP)
  - Trigger (R\_TRIG, F\_TRIG)
  - Flip-flops (RS, SR)
  - Counters (CTU, CTD, CTUD)
- Device-specific function modules:
  - C3\_Input: reading digital inputs
  - C3\_Output: writing digital inputs
  - C3\_ReadArray: access to recipe table
- Inputs/outputs:
  - 8 digital inputs (24 V level)

- 4 digital outputs (24 V level)
- 6 analog inputs (14 bits)
- 4 analog outputs (16 bits)
- Optional addition of 12 digital inputs/outputs

**PLCopen function blocks**

- Absolute positioning
- Relative positioning
- Additive positioning
- Continuous positioning
- Stop
- Machine zero
- Energizing the power output stage
- Reading device status
- Reading axis error
- Acknowledging errors
- Reading the current position
- Electronic gearbox (gearing)

**Example of an field bus interface controlled IEC61131-application**

- 2 control words are placed on the cyclic channel of the bus.
- The position data records (position, speed, acceleration etc.) are stored in a table (array).
- The desired position data record is selected with Controlword\_2.
- The individual bits of Controlword\_1 control positioning.
- A return message is sent via a status word on the cyclic channel of the bus.

**Example of a bus interface controlled IEC61131 application**

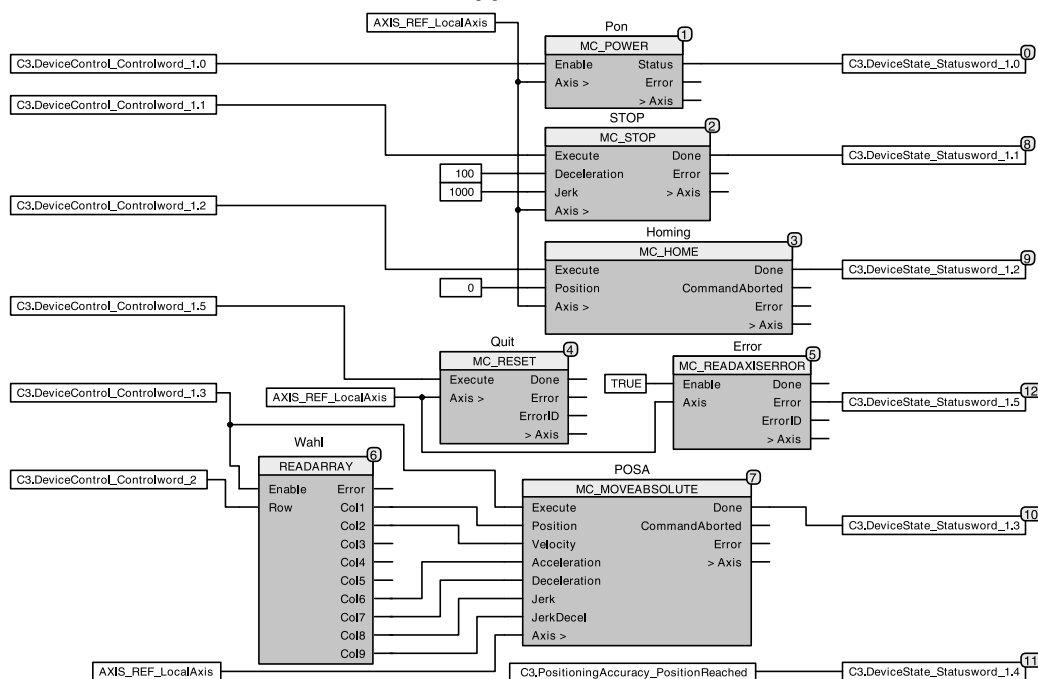



**General**

Compax3 T40 is able to simulate mechanical cams and cam switching mechanisms electronically. The T40 electronic cam was especially optimized for:

- The packaging machine industry
- The printing industry
- All applications, where a mechanical cam is to be replaced by a flexible, cyclic electronic solution

This helps to solve discontinuous material supply, flying-knife and similar drive applications using distributed drive technology.

Compax3 T40 supports both real and virtual master movements. In addition, the user can switch to other cam profiles or cam segments ,on the fly‘.

Programming is carried out in the well-known IEC61131-3 environment.

With the aid of the cam function modules and CamDesigner, cam applications can be implemented very easily.

**Function T40**

- Technology functions of the T30 version fully integrated and available
- Master position acquisition
- Mark synchronization
- Cam switching mechanism
- Coupling and decoupling function
- Cam profiles
- Cam memory
- Cam creation with CamDesigner

**Master position acquisition**

- Acquisition by incremental encoder
- Acquisition by the HEDA real-time bus
- Virtual Master:

A second axis in the IEC program can be used to program a motion profile, which serves as a master for one or several axes.

**Mark synchronization**

- Master or slave oriented (simultaneous, cam-independent)
- Highly-precise mark recognition (accuracy <1µs; Touch-probe)

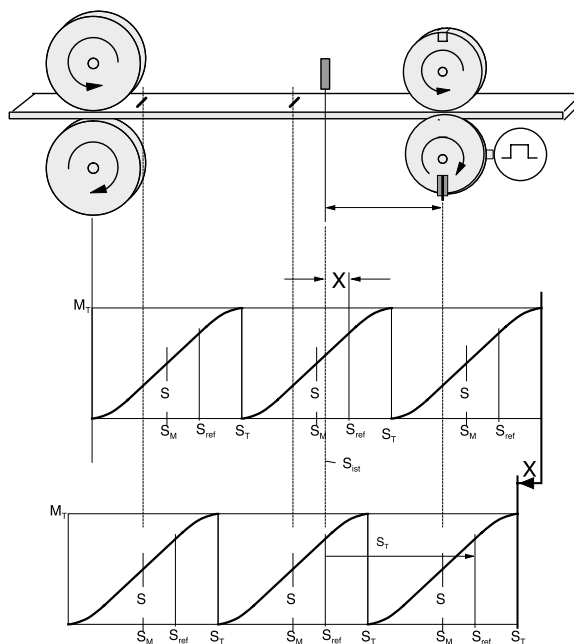

**Cam switching mechanism**

- 36 cams with individual profiles
- 4 fast cams (125 µs per cam) standard: 500 µs
- 32 serial cams, 16 ms/cam cycle (0.5 ms/cam)
- Delay-time compensated cams: Compax3 can advance the cam to compensate for delays in switching elements.

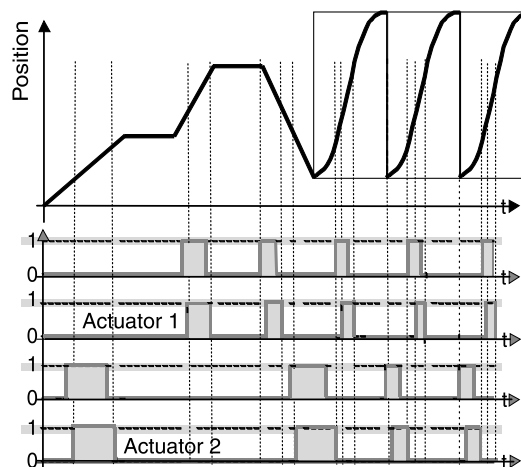

11

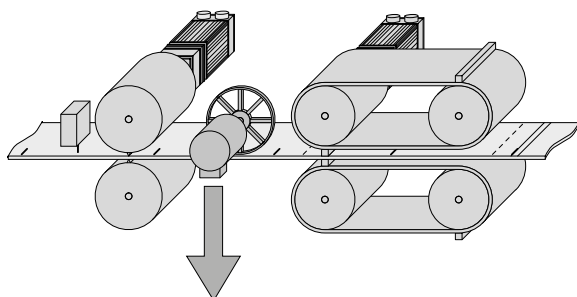

**Coupling and decoupling functions**

- By means of a set point generator
- By means of a change-over function
- Without overspeeding by coupling over several master cycles
- Virtually free set-up of the coupling and decoupling movement
- Master-guided coupling movement
- Random standstill position

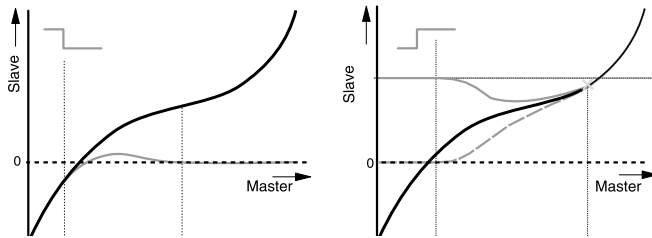

**Cam profiles**

- Up to 20 cam segments can be produced by:
- Virtually random cam links (forwards and backwards)
- Freely programmable event-controlled cam branches
- Scalable cam segments and complete cam profiles

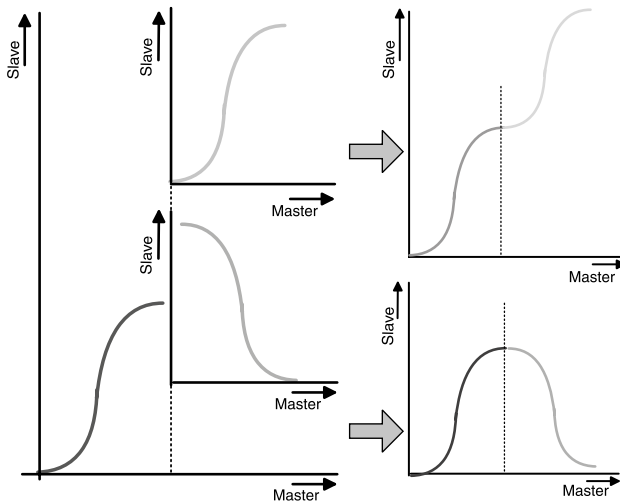

**Cam memory**

- 10,000 points (Master/Slave) in 24-bit format
- High-precision profile generation:
  - Variable point spacing with full backup of the current-master and slave coordinates (even if the power fails)
  - Linear interpolation between points
- Cam memory for up to 20 curves

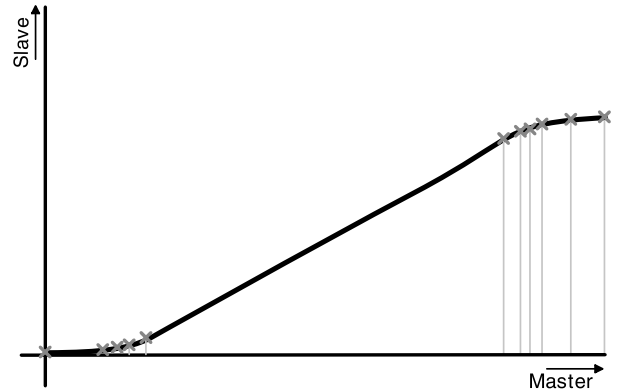

**Interfaces**

**Connection of high-level controllers**

**a) Control via digital inputs/outputs  
Compax3 I11T30 / I11T40 / I12T11**

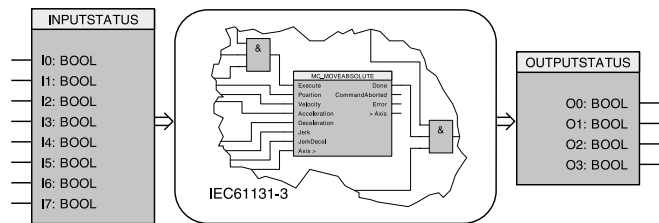

The digital I/Os can be optionally extended by 12 I/Os (M10 and M12 option).

**b) Control via Profibus,  
Compax3 I20T11 / I20T30 / I20T40**

Profibus-ratings	
DP-Versions	DPV0 / DPV1
Baud rate [MBit/s]	up to 12
Profibus ID	C320

**c) Control via CANopen, Compax3 I21T30 / I21T40**

CANopen-ratings	
Baud rate [kBit/s]	20, 50, 100, 125, 250, 500, 800, 1000
Service-Data-Object	SDO1
Process-Data-Objects	PDO1, ... PDO4

**d) Control via DeviceNet, Compax3 I22T30 / I22T40**

DeviceNet-ratings	
I/O - data	up to 32 bytes
Baud rate [kBit/s]	125...500
Nodes	up to 63 Slaves

**e) Control via Ethernet Powerlink,  
Compax3 I30T30 / I30T40**

Ethernet Powerlink ratings	
Baud rate	100 Mbits (FastEthernet)
Cycle time	<200 µs; to 240 nodes

**f) Control via EtherCAT  
Compax3 I31T30 / I31T40**

EtherCAT-ratings	
Bau drate	100 Mbits (FastEthernet)
Cycle time	<200 µs; to 240 nodes

**g) Control via Profinet I32T11 / I32T30 / I32T40**

Profinet ratings	
Profinet version	Profinet IO (RT)
Transmission mode	100 BASE-TX (Full Duplex)
Profinet ID	C332

**Software Tool C3 ServoManager**

Configuration is carried out on a PC using the Compax3 ServoManager.

- Wizard-guided configuration
  - Automatic querying of all necessary entries
  - Graphically supported selection
- Setup mode
  - Moving individual axes
  - Predefined profiles
  - Convenient operation
  - Storage of defined profiles
  - Controller pre-setting possible
- Integrated 4-channel oscilloscope
  - Signal tracing directly on the PC
  - Various modes (single/normal/auto/roll)
  - Zoom function
  - Export as image or table (for example to Excel)

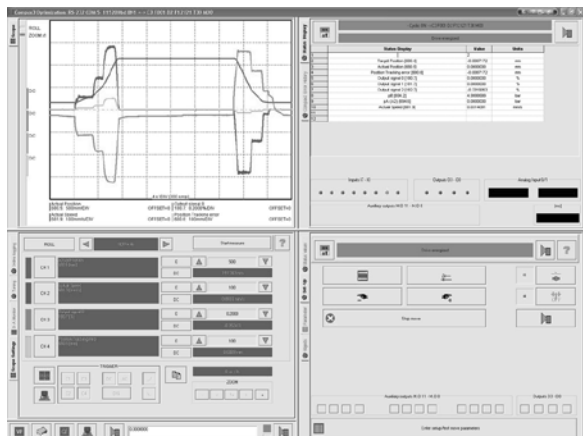

**Software Tool HydraulicsManager**

- Simple set up of customer valves, cylinders and drives.
- Technical data of all Parker valves, cylinders and drives available.



C3 HydraulicsManager valve database

**Software Tool CamDesigner**

- Standardized Nolte cam generating tool with:
  - Standard or extended range of functions
  - Evaluation of the motion profiles
  - Verification of the drive sizing
- Transition laws from VDI directive 2143:
  - Selection of motion laws
  - The CamDesigner basic version features 15 motion laws (based on the dwell-to-dwell (interpolation method))

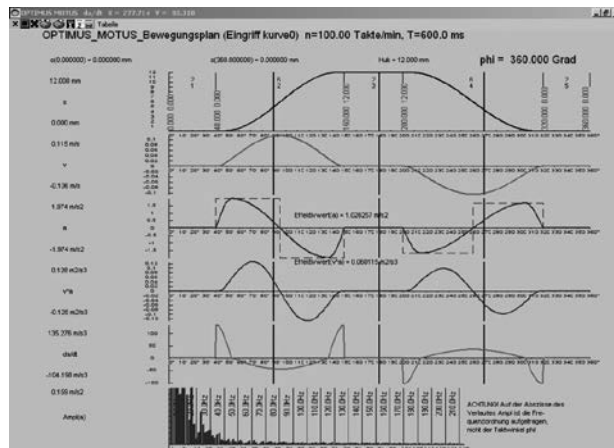

Evaluation of the motion profile

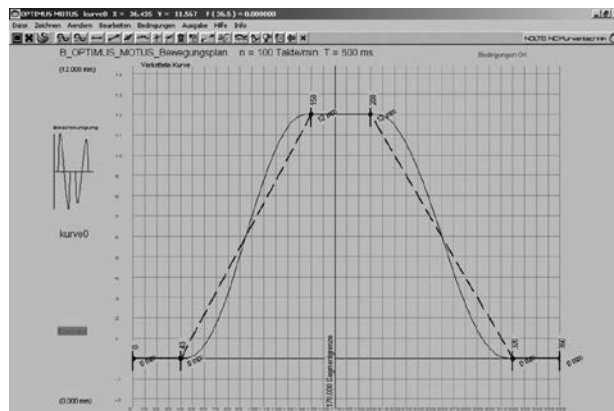

Cam generation with the integrated CamEditor

**IEC61131-3 Programming language**

IEC61131-3 is the only company- and product-independent programming language with worldwide support for industrial automation devices.

- IEC61131-3 includes graphical and textual programming languages:
  - Instruction list
  - Structured text
  - Ladder diagram
  - Sequential function chart
  - Function block diagram

Integrated standards offer:

- A trusted programming environment
- Standardized programming

Integrated standards reduce:

- The overhead of development
- Maintenance costs
- Software upkeep
- Training overhead

Integrated standards increase:

- Productivity
- Software quality
- Concentration on core competence

**Examples**

- Program development in IL

```

0001 FUNCTION_BLOCK AWL_EXAMPLE
0002 (* Sinus und CoSinus einer Zahl berechnen *)
0003 VAR_INPUT
0004   r1: REAL := 0.0;
0005 END_VAR
0006 VAR_OUTPUT
0007   sinus: REAL;
0008   cosinus: REAL := 9.9;
0009 END_VAR
0010
0011 (* Den Sinus einer Zahl berechnen und mit 1000 multiplizieren *)
0012 LD   r1
0013 SIN
0014 MUL  1000.0
0015 ST   sinus
0016
0017 (* Den Cosinus einer Zahl berechnen und mit 1000 multiplizieren *)
0018 LD   r1
0019 COS
0020 MUL  1000.0
0021 ST   cosinus
0022
0023 (* Die Zahl weiterschalten *)
0024 LD   r1
0025 ADD  0.1
0026 ST   r1
    
```

- Instruction list (IL)

```

LD      A
ANDN   B
ST      C
    
```

- Ladder diagram

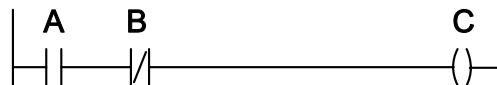

- Structured text

```
C := A AND NOT B
```

- Function plan

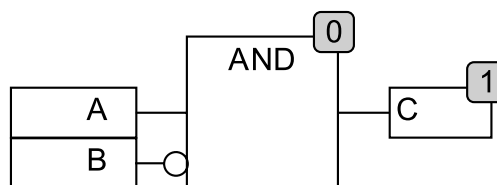

**Function modules based on PLCopen**

PLCopen is a product- and company independent organization that plays a significant role in supporting the IEC61131-3 programming language. Its specific tasks also include defining basic processes relevant to motion. The PLCopen organization consists of both users and manufacturers of automation components.

Parker Hannifin is an active member of the “Motion Control” task force. This is a great advantage for the users of Parker drive technology, since they are constantly able to profit directly from the latest developments in PLCopen.

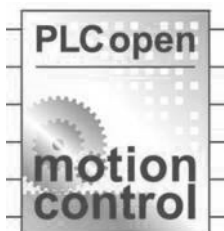

**Professional development tool CoDeSys**

CoDeSys is a development environment for programming that saves a significant amount of time as applications are created.

- One of the most powerful development environments available, established world-wide
- Universal programming platform for various devices
- Visual elements
- Library management for user-defined applications
- Context-sensitive help wizard
- Data exchange between devices from different manufacturers
- Complete online functionality
- Sophisticated technological features
- Standard function modules deposited  
 ... and all this free of charge

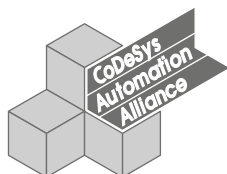

Parker is a member of the “CoDeSys Automation Alliance“.

**Program development in CFC**

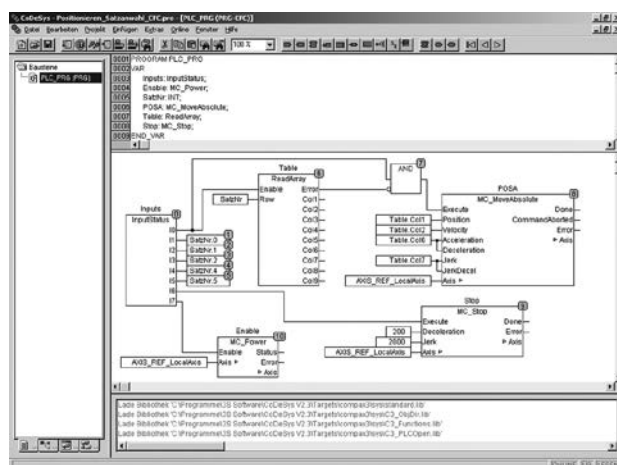

**Project management**

Saving an entire project (source file) including symbols and comments to make service calls easier, because there is no need for any project data on the device itself

- Archiving projects as ZIP files
- Creating user-specific libraries that can be reused as tested sections of programs
  - These libraries can be protected
  - Examples include winders, synchronization components etc.
- Various user levels make it possible to lock sections of the program with passwords
- Depending on the task at hand, users can select from among 5 IEC languages plus CFC. These languages can also be mixed

**Accessories**

**Servo Drive  
Series Compax3F**

**Connection set ZBH../.. (included in delivery)**

Complete kit with mating plug connectors (X1, X2 and X3) for Compax3 connectors, special shield connecting terminal and snap-on foot for mounting rail.

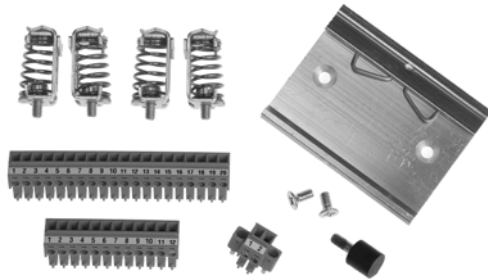

**Feedback cable GBK../..**

Connection to the transducer:

Under the designation "REK.. + GBK.." (Feedback cable) we can deliver feedback connecting cables in various lengths to order.

- Prefabricated with plug and cable eye
- The plugs of the feedback cables contain a special surface area screening.
- Cable plans, if you wish to make up your own cables



**Terminal block EAM06../..**

For additional wiring of the inputs and outputs:

- Available with or without LED display
- Can be mounted in the control cabinet on a supporting rail
- Connection EAM06../.. via SSK23../.. to X11, SSK24../.. to X12

**RS232 cable SSK01../..**

(in various lengths).

Configuration:

Via a PC with the aid of the Compax3 ServoManager.

Communication:

Communication with Compax3 either via RS232 or via RS485 in order to read or write into objects.



**Profibus plug BUS08/01**

- BUS08/01 with 2 cable inputs (1x BUS08/01 incoming, 1x BUS08/01 continuing) and screw terminals, as well as a switch for activating the terminating resistor. Set to ON for first and last bus node terminating resistor activated.

**Profibus cable: SSL01../.. not prefabricated**

- Special cable in any length for Profibus wiring (colors according to DESINA).



**HEDA Bus**

HEDA bus terminal connector (RJ45) BUS07/01:

- For the first and last Compax3 in the HEDA bus.

HEDA cable: SSK28../.. prefabricated in various lengths:

- Cable for HEDA bus wiring from Compax3-to-Compax3 or PC-to-Compax3 powerPLmC or wiring of
  - Ethernet Powerlink (I30)
  - EtherCAT (I51)
  - Profinet (I32)



**CANbus plug BUS10/01**

- BUS10/01 with 2 cable inputs (1x BUS10/01 incoming, 1x BUS10/01 continuing) and screw terminals, as well as a switch for activating the terminating resistor. Set to ON for first and last bus node terminating resistor activated

**CANbus cable SSL02../.. not prefabricated**

- Special cable in any length for CANbus wiring (colours according to DESINA)



11

Connection set for Compax 3										
for C3F001 D2 F12xxx	ZBH 02/04	Z	B	H	0	2	/		0	4
Terminal block										
for I/Os without luminous indicator	for X11, X12	E	A	M	0	6	/		0	1
for I/Os with luminous indicator	for X12	E	A	M	0	6	/		0	2
Interface cables and connectors										
PC-Compax3 (RS232)		S	S	K	0	1	/		...	... <sup>1)</sup>
on X11/X13 (Transducer)	With flying leads	S	S	K	2	1	/		...	... <sup>1)</sup>
on X12 (I/O digital)	With flying leads	S	S	K	2	2	/		...	... <sup>1)</sup>
on X11(Ref/Analog)	For I/O terminal	S	S	K	2	3	/		...	... <sup>1)</sup>
on X12 (I/Os digital)	For I/O terminal	S	S	K	2	4	/		...	... <sup>1)</sup>
PC - POP (RS232)		S	S	K	2	5	/		...	... <sup>1)</sup>
Compax3 - POP (RS485)		S	S	K	2	7	/	..	...	... <sup>3)</sup>
Compax3 HEDA - Compax3 HEDA or PC - C3powerPLmC or Ethernet Powerlink (I30), EtherCAT (I31), Profinet (I32)		S	S	K	2	8	/		...	... <sup>2)</sup>
Compax3 X11 - Compax3 X11 (Encoder coupling of 2 axes)		S	S	K	2	9	/		...	... <sup>1)</sup>
HEDA bus terminal connector (for the 1st and the last Compax3 in the HEDA Bus)		B	U	S	0	7	/		0	1
Feedback cable for Balluff SSI transducer and start/stop		G	B	K	4	0	/		...	... <sup>1)</sup>
Feedback cable for SSI transducer and start/stop	With flying leads	G	B	K	5	3	/		...	... <sup>1)</sup>
Profibus cable <sup>4)</sup>	Not prefabricated	S	S	L	0	1	/		...	... <sup>1)</sup>
Profibus connector		B	U	S	0	8	/		0	1
CAN-Bus cable <sup>4)</sup>	Not prefabricated	S	S	L	0	2	/		...	... <sup>1)</sup>
CAN-Bus connector		B	U	S	1	0	/		0	1

**Length code for SSK27**

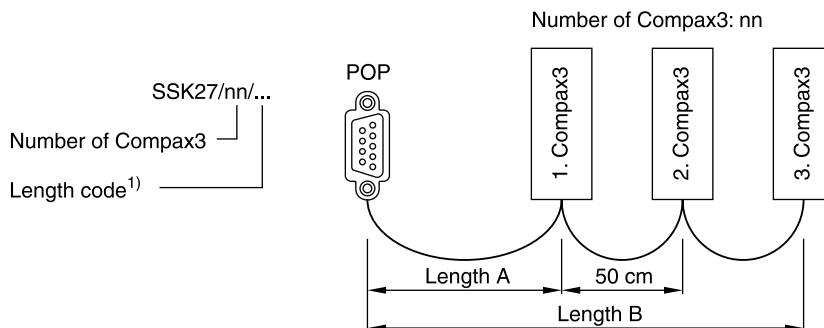

<sup>1)</sup> Length code

Length code 1 (Example: SSK01/09: Length 25 m)

Length [m]	1.0	2.5	5.0	7.5	10.0	12.5	15	20	25	30	50
Code	01	02	03	04	05	06	07	08	09	10	14

<sup>2)</sup> Length code for SSK28

Length code 2 (Example: SSK28/22: Length 3 m)

Length [m]	0.25	0.5	1.0	3.0	5.0	10.0
Code	20	21	01	22	03	05

<sup>3)</sup> Length code for SSK27

Length A: Cable or connection from POP with **one** Compax3 (POP - 1.Compax3), variable length according to length code<sup>1)</sup>  
 (Example: SSK27/01/01: Length 1.0 m)

Length B: Cable or connection from POP with **more than one** Compax3 (nn > 01) (1.Compax3 - 2.Compax3 - ...), length between Compax connectors is fixed to 50 cm, variable length A from POP with first Compax according to length code<sup>1)</sup>  
 (Example: SSK27/03/01: Length 1.0 m)

<sup>4)</sup> Colours according to DESINA