

# Proportional pressure reducing valve, pilot-operated

## Type DRE(E) and ZDRE(E)



- ▶ Size 6
- ▶ Component series 1X
- ▶ Maximum operating pressure: 210 bar (DRE)  
315 bar (ZDRE)
- ▶ Maximum flow 30 l/min



### Features

- ▶ For pressure reduction in ports A and P① with pressure limitation
- ▶ Operation by means of proportional solenoids
- ▶ For subplate mounting or sandwich plate design
- ▶ Porting pattern according to ISO 4401-03-02-0-05
- ▶ Low manufacturing tolerance of the command value pressure characteristic curve due to electrical adjustment for the operation with external control electronics
- ▶ Minimum set pressure in ports A or P①
- ▶ With integrated electronics (OBE), optional
- ▶ CE conformity according to EMC Directive 2014/30/EU

### Contents

Features	1
Ordering code	2, 3
Symbols	3
Function, section	4, 5
Technical data	6, 7
Electrical connections and assignment	8
Characteristic curves	9 ... 13
Dimensions	14 ... 18
Accessories	18

**Ordering code**

01	02	03	04	05	06	07	08	09	10	11	12	13	14	15
	<b>DRE</b>		<b>6</b>			<b>-</b>	<b>1X</b>	<b>/</b>		<b>M</b>	<b>G24</b>			<b>*</b>

01	Subplate mounting	<b>no code</b>
	Sandwich plate design	<b>Z</b>
02	Proportional pressure reducing valve	<b>DRE</b>
03	For external control electronics	<b>no code</b>
	With integrated electronics (OBE)	<b>E</b>
04	Size 6	<b>6</b>
05	Pressure reduction in channel A (subplate mounting)	<b>no code</b>
	Pressure reduction in channel P① (sandwich plate design)	<b>VP</b>

**Position of the mating connector** (only sandwich plate design)

06		<b>1</b>
		<b>2</b>
		<b>3</b>
		<b>4</b>

07	Component series 10 ... 19 (10 ... 19: unchanged installation and connection dimensions)	<b>1X</b>
----	--	-----------

**Pressure rating**

08	50 bar	<b>50</b>
	100 bar	<b>100</b>
	210 bar	<b>210</b>
	315 bar	<b>315<sup>2)</sup></b>

09	Without check valve	<b>M</b>
----	---------------------	----------

**Supply voltage**

10	Direct voltage 24 V	<b>G24</b>
11	With manual override	<b>N9</b>
	Without manual override	<b>no code</b>

## Ordering code

01	02	03	04	05	06	07	08	09	10	11	12	13	14	15
	<b>DRE</b>		<b>6</b>			<b>- 1X</b>	<b>/</b>		<b>M</b>	<b>G24</b>				<b>*</b>

### Electrical connection

12	<b>- Type DRE and ZDRE</b>	
	Without mating connector; connector DIN EN 175301-803	<b>K4</b> <sup>3)</sup>
	<b>- Type DREE and ZDREE</b>	
	Without mating connector; connector M12	<b>K24</b> <sup>3)</sup>

### Electronics interface

13	External control electronics	<b>no code</b>
	Command value 0 ... 10 V	<b>A1</b>
	Command value 4 ... 20 mA	<b>F1</b>

### Seal material (observe compatibility of seals with hydraulic fluid used, see page 7)

14	NBR seals	<b>M</b>
	FKM seals	<b>V</b>
09	Further details in the plain text	

- 1) Valve contact surface (seal ring recesses in the housing)
- 2) Only available for "Z" version
- 3) Mating connectors and cable sets, separate order, see page 18 and data sheet 08006.

## Symbols (① = component side, ② = plate side)

**Type DRE**

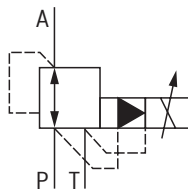

**Type DREE**

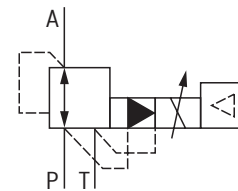

**Type ZDRE**

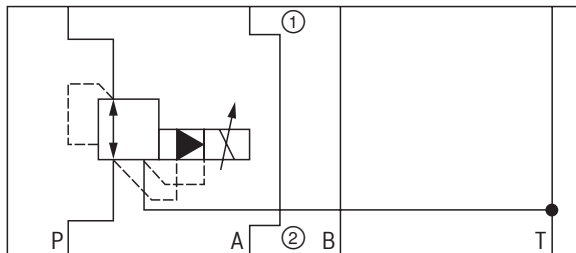

**Type ZDREE**

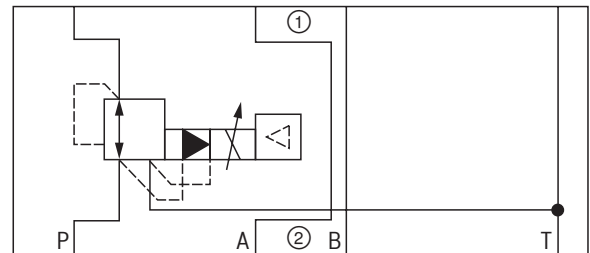

**Function, section:** Type (Z)DRE

The valve types DRE and ZDRE are electrically pilot-operated 3-way pressure reducing valves with pressure limitation of the actuator. They are used for reducing a system pressure.

The valve basically consists of a pilot control valve (1), proportional solenoid (2), main valve (3) with main control spool (4).

**Type DRE**

- ▶ Command value-dependent setting of the pressure to be reduced in channel A via the proportional solenoid (2).
- ▶ In the depressurized port P, the spring (17) holds the main control spool (4) in the initial position.
- ▶ Thus, opening the connection from A to T and blocking of the connection from P to A.
- ▶ Pressure connection from port P to the ring channel (5).
- ▶ Pilot oil flows from the bore (6) to port T, via the flow controller (7), the nozzle (8) to the pilot control valve (1), the throttle gap (9) to the longitudinal groove (10) and the bores (11, 12).

- ▶ Pressure reduction
  - Build-up of the pilot pressure in the control chamber (16) as function of the command value.
  - Movement of the main control spool (4) to the right, hydraulic fluid flows from P to A.
  - Actuator pressure pending in port A to the spring chamber (15) via channel (13) and nozzle (14).
  - Increase in the pressure in port A to the set pressure of the pilot control valve (1) leads to the movement of the main control spool (4) to the left. Pressure in port A is almost identical with the set pressure at the pilot control valve (1).
- ▶ Pressure limitation
  - If the pressure in port A exceeds the set pressure of the pilot control valve (1), the main control spool (4) will be moved further to the left.
  - Thus, opening of the connection from A to T and limitation of the pressure pending in port A to the set command value.

**Type ZDRE**

In principle, the function of this valve version corresponds to the function of type DRE.

However, the pressure is reduced in channel P①.

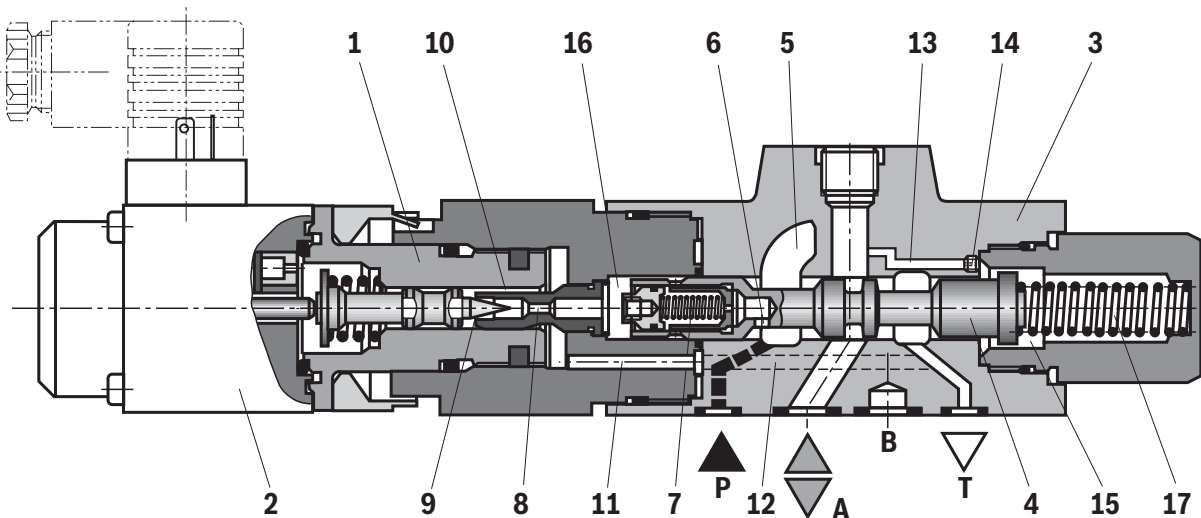

Type DRE ...

**Function, section:** Type (Z)DREE**Type (Z)DREE** – with integrated electronics (OBE)

With regard to function and design, these valves correspond to type (Z)DRE. On the proportional solenoid (2), there is moreover a housing (18) with the control electronics.

Supply and command value voltage or command value current

are applied to the connector (19).

In the factory, the command value pressure characteristic curve is adjusted with little manufacturing tolerance.

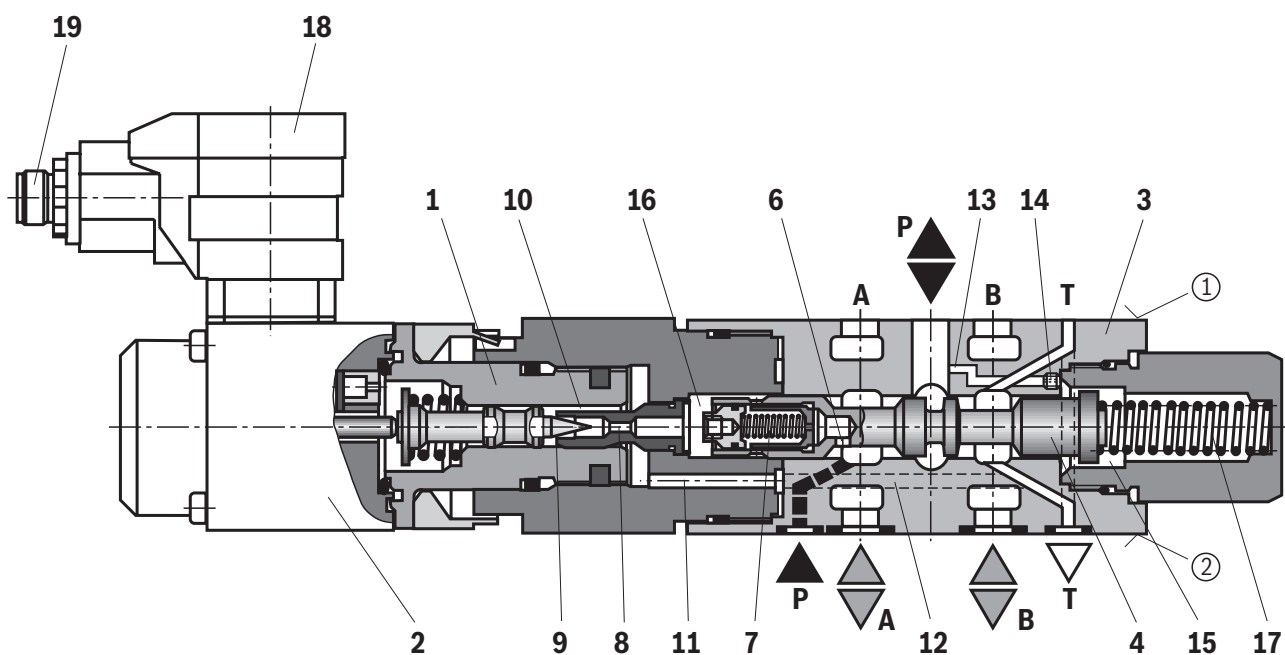
**Type ZDREE ...**

① = component side

② = plate side

**Technical data**

(For applications outside these values, please consult us!)

<b>General</b>			
Weight	▶ Type (Z)DRE	kg	2.0
	▶ Type (Z)DREE	kg	2.1
Installation position			any
Storage temperature range			°C -20 ... +80
Ambient temperature range			°C -20 ... +70
Protection class according to EN 60529			IP65 (if suitable and correctly mounted mating connectors are used)
Conformity	▶ CE according to EMC directive 2014/30/EU, tested according to		EN 61000-6-2 and EN 61000-6-3

<b>Hydraulic</b>			
Maximum operating pressure	▶ Port P or P②	bar	315
	▶ Port P①, A and B	bar	210
	▶ Port T	bar	separate and depressurized to the tank
Maximum set pressure in channels P① and A	▶ Pressure rating 50 bar	bar	50
	▶ Pressure rating 100 bar	bar	100
	▶ Pressure rating 210 bar	bar	210
	▶ Pressure rating 315 bar	bar	315 <sup>1)</sup>
Minimum set pressure with command value 0 in port A or P①		bar	see characteristic curves page 11
Pilot flow		l/min	0.65
Maximum flow		l/min	30
Hydraulic fluid			see table page 7
Hydraulic fluid temperature range			°C -20 ... +80
Viscosity range			mm <sup>2</sup> /s 15 ... 380
Maximum admissible degree of contamination of the hydraulic fluid, cleanliness class according to ISO 4406 (c)			Class 20/18/15 <sup>2)</sup>

1) Only available for "Z" version.

2) The cleanliness classes specified for the components must be adhered to in hydraulic systems. Effective filtration prevents faults and at the same time increases the life cycle of the components.

<b>Static/dynamic</b>			
Hysteresis		%	±2.5 <sup>3)</sup>
Repetition accuracy		%	< ±2 <sup>3)</sup>
Linearity	▶ Type (Z)DRE	%	±3.5 <sup>3)</sup>
Manufacturing tolerance of the command value pressure characteristic curve, related to the hysteresis characteristic curve, pressure increasing	▶ Type (Z)DRE	%	±2 <sup>3)</sup>
	▶ Type (Z)DREE	%	±3 <sup>3)</sup>
Step response $T_u + T_g$ <sup>4)</sup>	▶ 10% → 90%	ms	~150
	▶ 90% → 10%	ms	~150

3) Of the maximum set pressure

4) Measured with 1 liter standing hydraulic fluid column

**Technical data**

(For applications outside these values, please consult us!)

Hydraulic fluid	Classification	Suitable sealing materials	Standards	Data sheet	
Mineral oils	HL, HLP	NBR, FKM	DIN 51524	90220	
Bio-degradable	▶ Insoluble in water	HETG	ISO 15380	90221	
		HEES			
	▶ Soluble in water	HEPG	ISO 15380		
Flame-resistant	▶ Water-free	HFDU (glycol base)	ISO 12922	90222	
		HFDU (ester base)			
		HFDR			
	▶ Containing water	HFC (Fuchs: Hydrotherm 46M, Renosafe 500; Petrofer: Ultra Safe 620; Houghton: Safe 620; Union: Carbide HP5046)	NBR	ISO 12922	90223

**Important information on hydraulic fluids:**

- ▶ For further information and data on the use of other hydraulic fluids, please refer to the data sheets above or contact us.
- ▶ There may be limitations regarding the technical valve data (temperature, pressure range, life cycle, maintenance intervals, etc.).
- ▶ The ignition temperature of the hydraulic fluid used must be 50 K higher than the maximum surface temperature.
- ▶ **Bio-degradable and flame-resistant – containing water:** If components with galvanic zinc coating (e.g. version "J3" or "J5") or parts containing zinc are used, small amounts of dissolved zinc may get into the hydraulic system and cause accelerated aging of the hydraulic fluid. Zinc soap may form as a chemical reaction product, which may clog filters, nozzles and solenoid valves – particularly in connection with local heat input.

**▶ Flame-resistant – containing water:**

- Due to the increased cavitation tendency with HFC hydraulic fluids, the life cycle of the component may be reduced by up to 30% as compared to the use with mineral oil HLP.
- Dependent on the hydraulic fluid used, the maximum environment and hydraulic fluid temperature must not exceed 50 °C. In order to reduce the heat input into the component, the command value profile is to be adjusted for proportional and high-response valves.

Electrical			
Supply voltage		VDC	24
Minimum control current		mA	100
Maximum control current		mA	1600
Solenoid coil resistance	▶ Cold value at 20 °C	Ω	5
	▶ Maximum hot value	Ω	7.5
Switch-on duration		%	100

Electrical, integrated electronics (OBE)			
Supply voltage	▶ Nominal value	VDC	24
	▶ Minimum	VDC	18
	▶ Maximum	VDC	35
Current consumption		A	≤ 1.5
Fuse protection, external		A	2.0 time-lag
Inputs	▶ Voltage	V	0 ... 10
	▶ Current	mA	4 ... 20

## Electrical connections and assignment

### Connector pin assignment "A1" and "F1"

Contact	Interface	
	"A1" (6 + PE)	"F1" (6 + PE)
1	24 VDC supply voltage ( $u(t) = 21 \dots 35 \text{ V}$ ); $I_{\max} \leq 1,5 \text{ A}$	
2	Command value 0 ... 10 V ( $R_e > 20 \text{ k}\Omega$ )	Command value 4 ... 20 mA ( $R_e = 100 \Omega$ )
3	0 V (ground)	
4	Reference potential command value	



### Type (Z)DRE

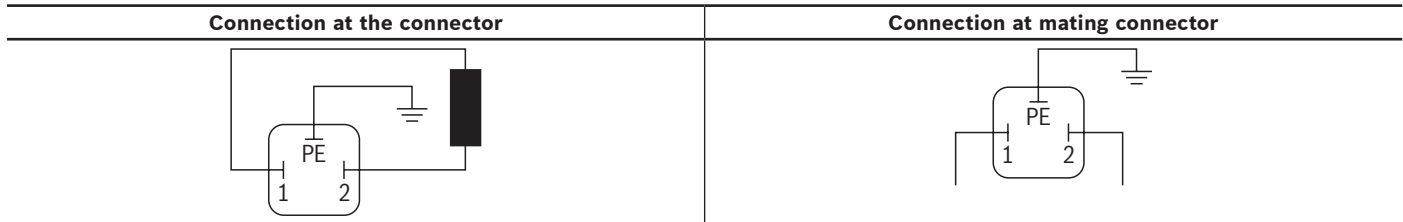

#### Connection cable (recommendation):

- ▶ 6-wire, 0.75 or 1 mm<sup>2</sup> plus protective grounding conductor and screening
  - ▶ Only connect the screening to PE on the supply side
  - ▶ Maximum admissible length = 100 m
- The minimum supply voltage at the power supply unit depends on the length of the supply line (see diagram).

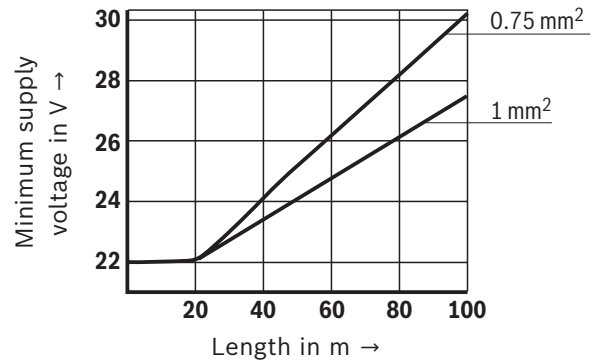



**Characteristic curves: Type (Z)DRE**  
 (measured with HLP46,  $\vartheta_{oil} = 40 \pm 5 \text{ }^\circ\text{C}$ )

**Reduced pressure in port A or P① of the command value (manufacturing tolerance)**

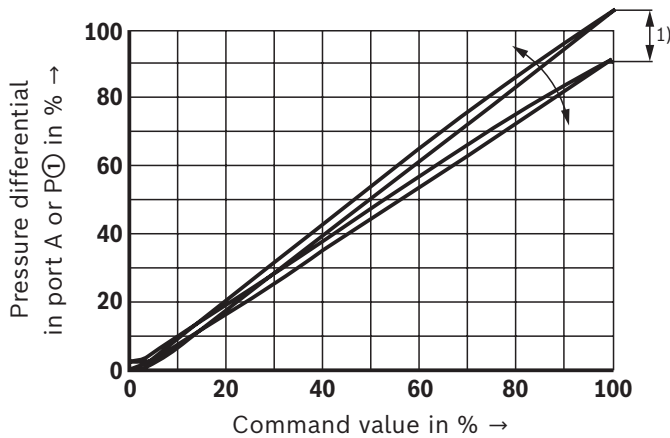

1) In order to be able to adjust several valves to the same characteristic curve, the manufacturing tolerance can - with version "(Z)DRE" - be changed at the external amplifier (see page 18) using the command value attenuator "G". In this connection, do not set the pressure higher than the maximum set pressure of the pressure rating with command value 100%.

**Pressure in port A or P① dependent on the command value**

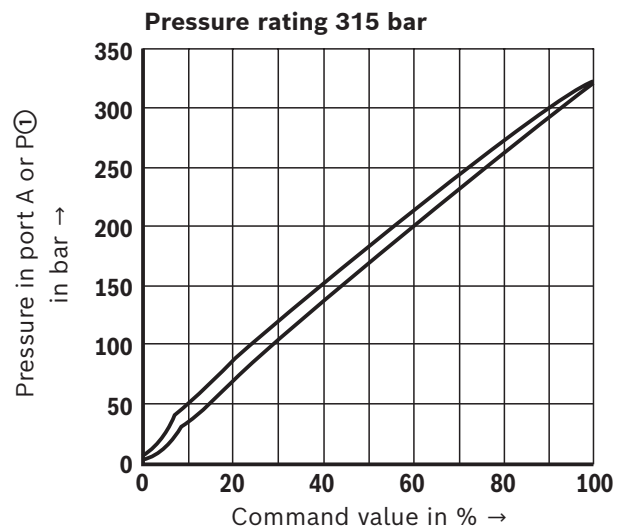
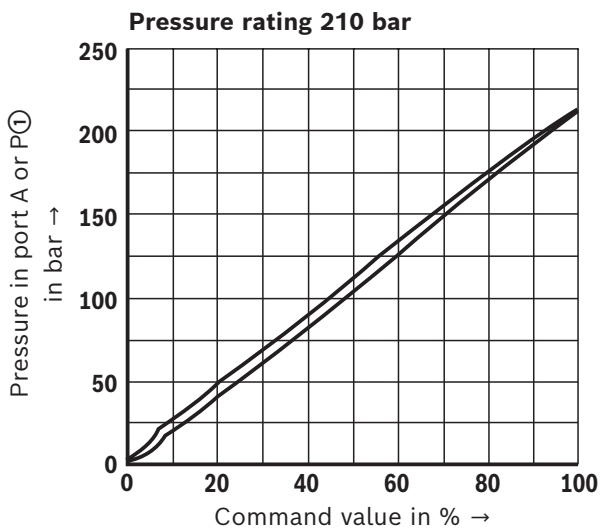
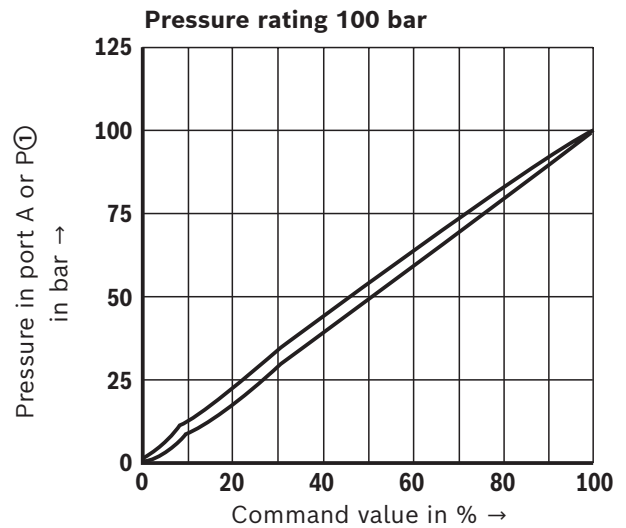
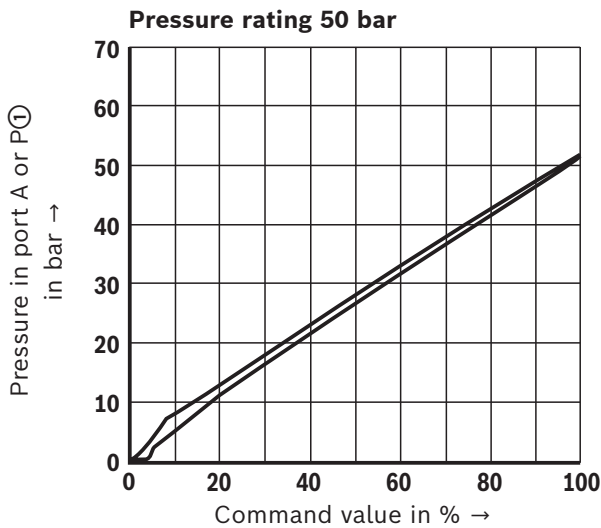

**Characteristic curves:** Type (Z)DREE  
 (measured with HLP46,  $\vartheta_{oil} = 40 \pm 5 \text{ }^\circ\text{C}$ )

Pressure in port A or P① dependent on the command value

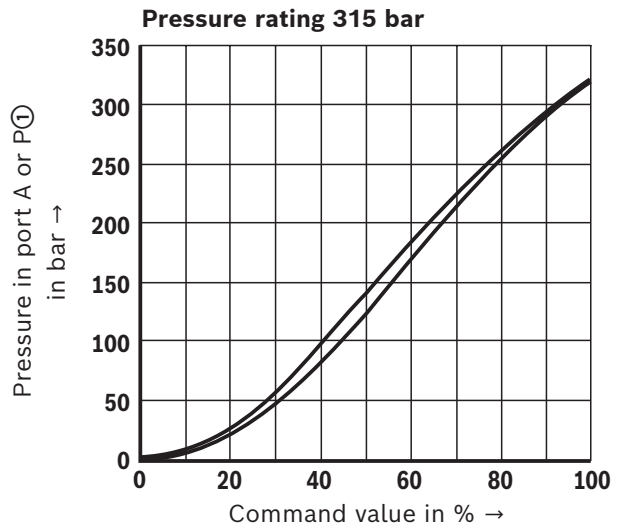
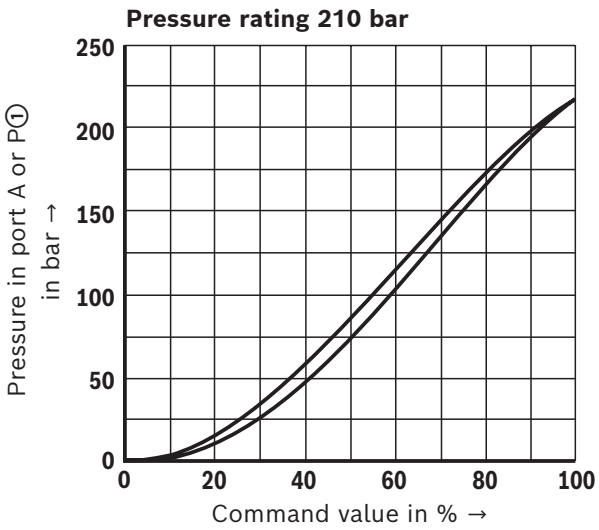
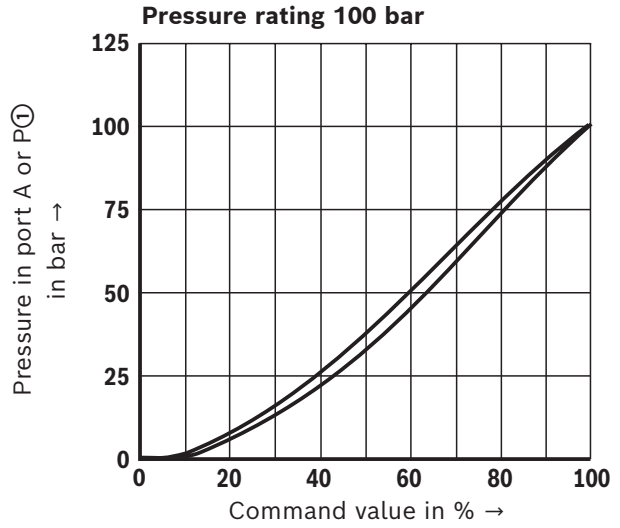
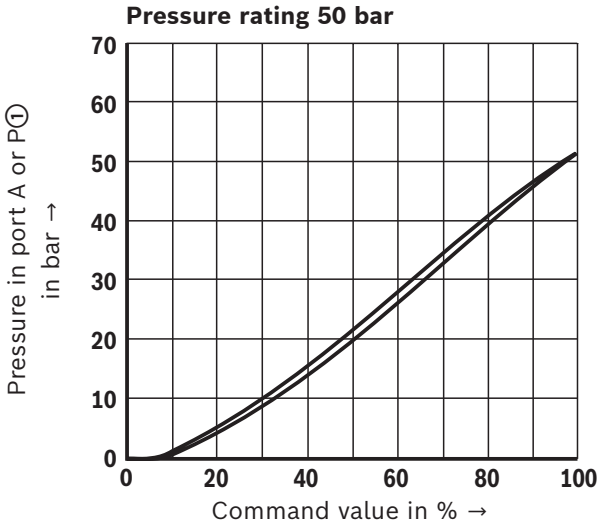

**Characteristic curves**

(measured with HLP46,  $\vartheta_{oil} = 40 \pm 5 \text{ }^\circ\text{C}$ )

**Minimum set pressure in port A or P① with command value 0 V** (without counter pressure in channel T)

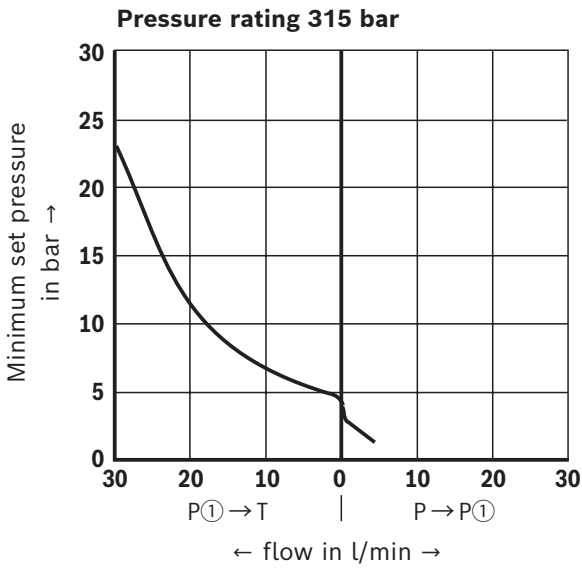
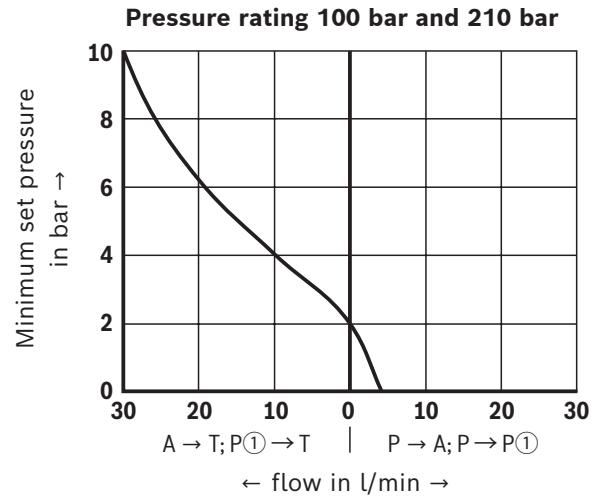
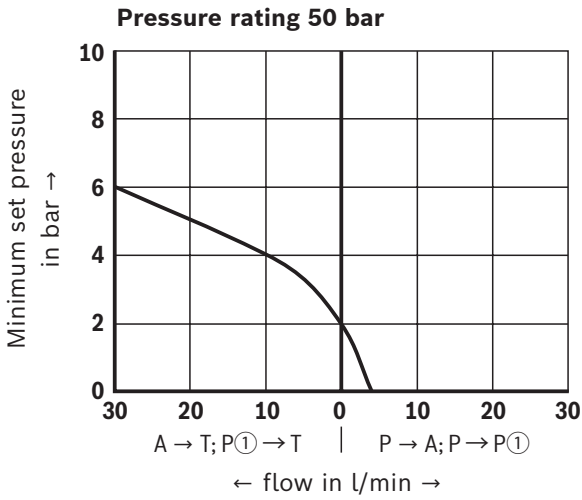

### Characteristic curves

(measured with HLP46,  $\vartheta_{oil} = 40 \pm 5 \text{ }^\circ\text{C}$ )

Pressure in port A or P① dependent on the flow

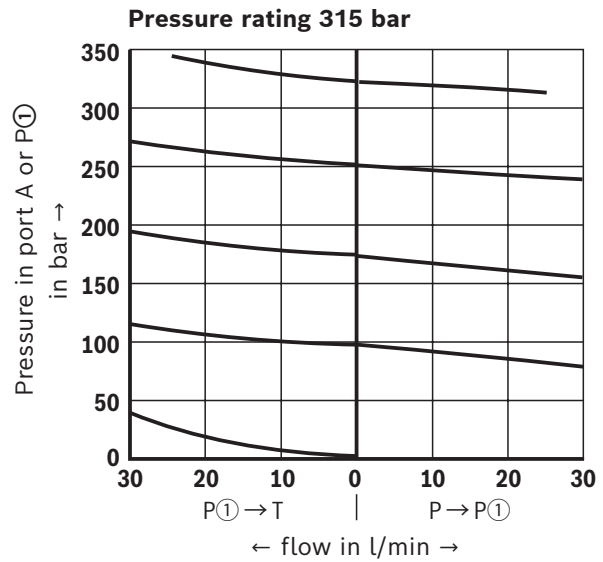
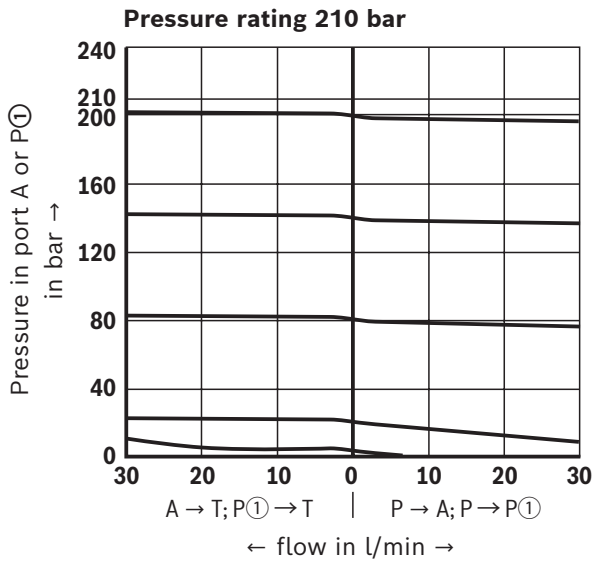
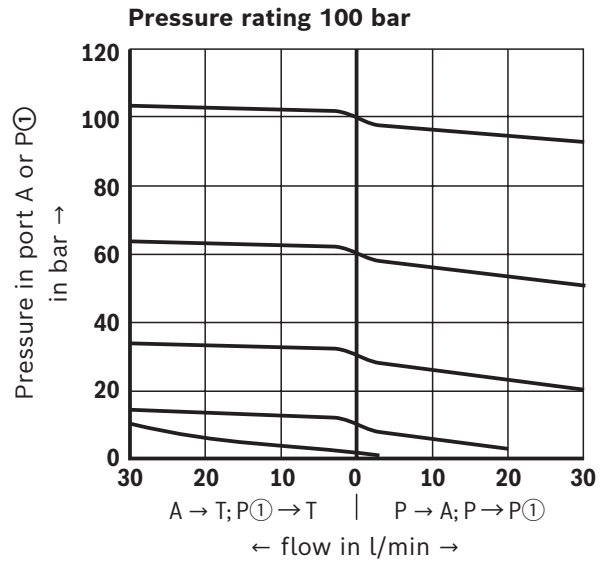
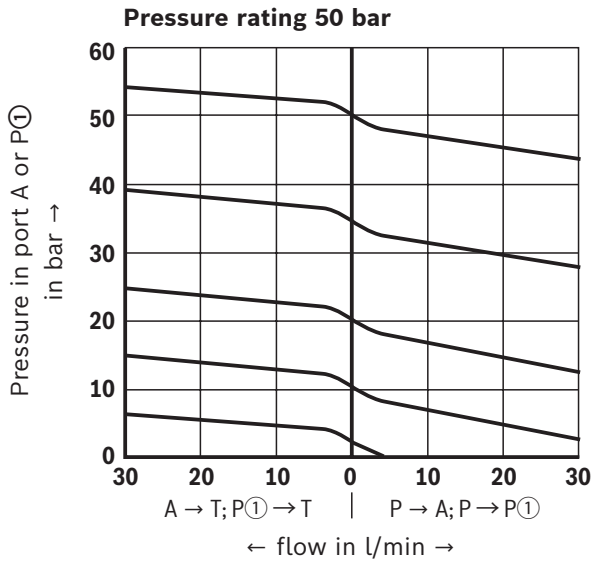

### Characteristic curves

(measured with HLP46,  $\vartheta_{oil} = 40 \pm 5 \text{ }^\circ\text{C}$ )

#### $\Delta p$ - $q_V$ characteristic curves

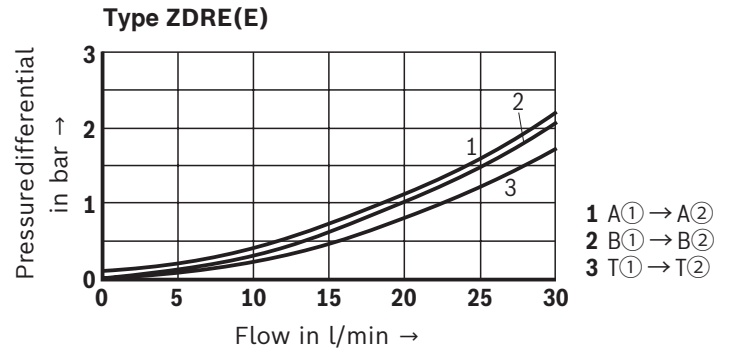
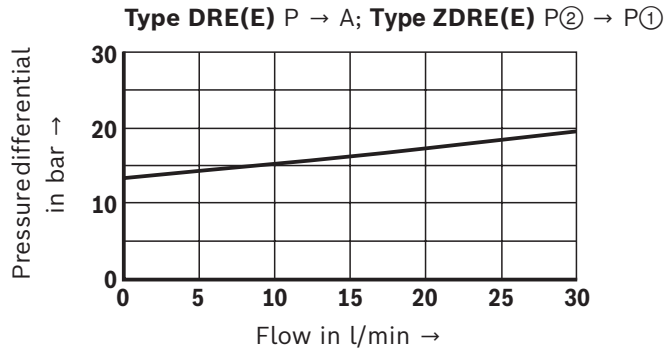

**Notice:**

The specified pressure differential corresponds to the minimum pressure available in port P (P②) minus the maximum pressure to be controlled in port A (P①).

**Dimensions:** Type DRE  
(dimensions in mm)

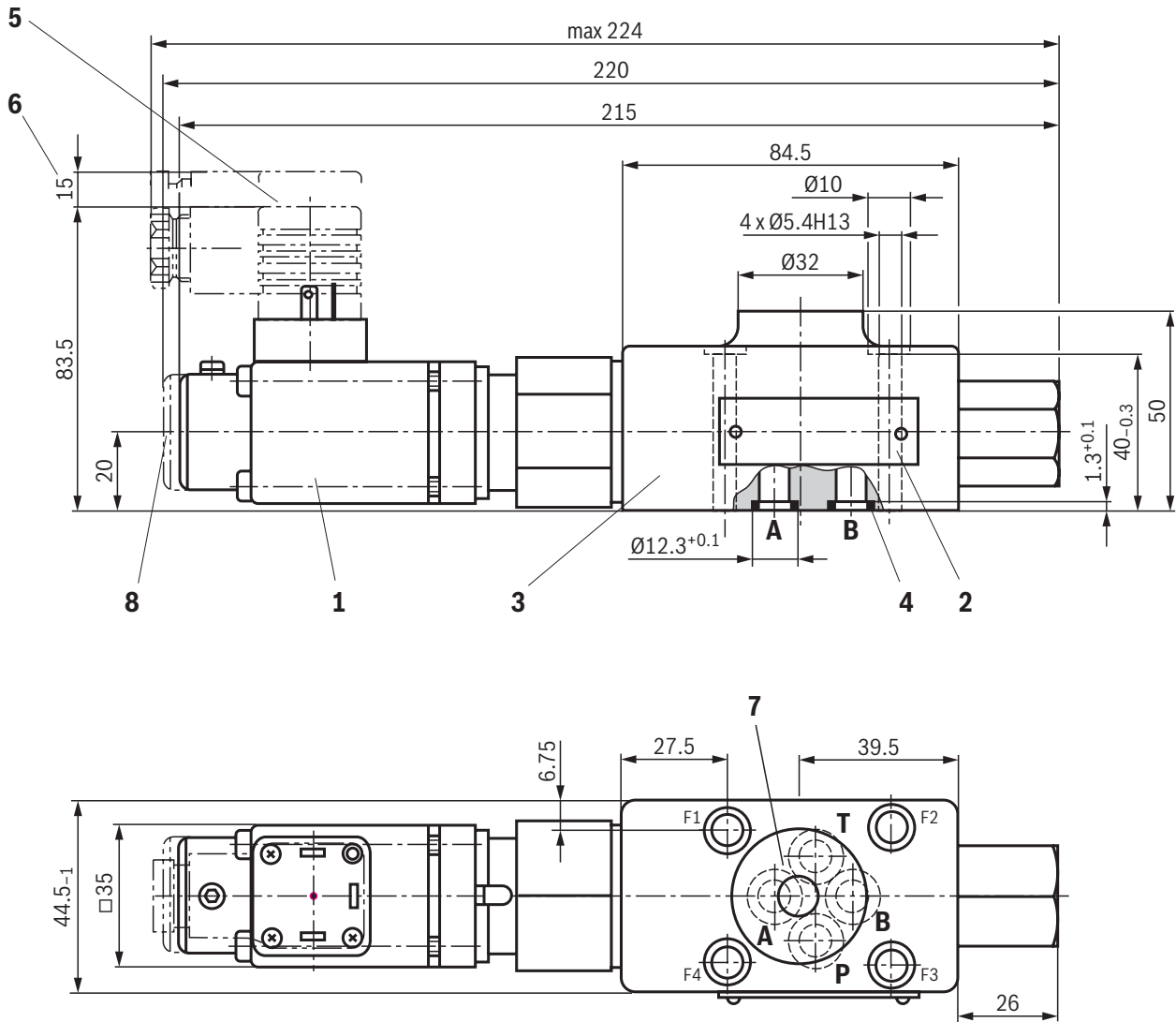

- 1 Proportional solenoid without manual override
- 2 Name plate
- 3 Valve housing
- 4 Identical seal rings for ports A, B, P and T
- 5 Mating connector, separate order, see page 18
- 6 Space required for removing the mating connector
- 7 Porting pattern according to ISO 4401-03-02-0-05
- 8 Proportional solenoid with manual override

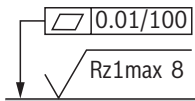
  
 Required surface quality of the valve contact surface

**Valve mounting screws and subplates**, see page 18.

**Notice:**

The dimensions are nominal dimensions which are subject to tolerances.

**Dimensions:** Type DREE  
(dimensions in mm)

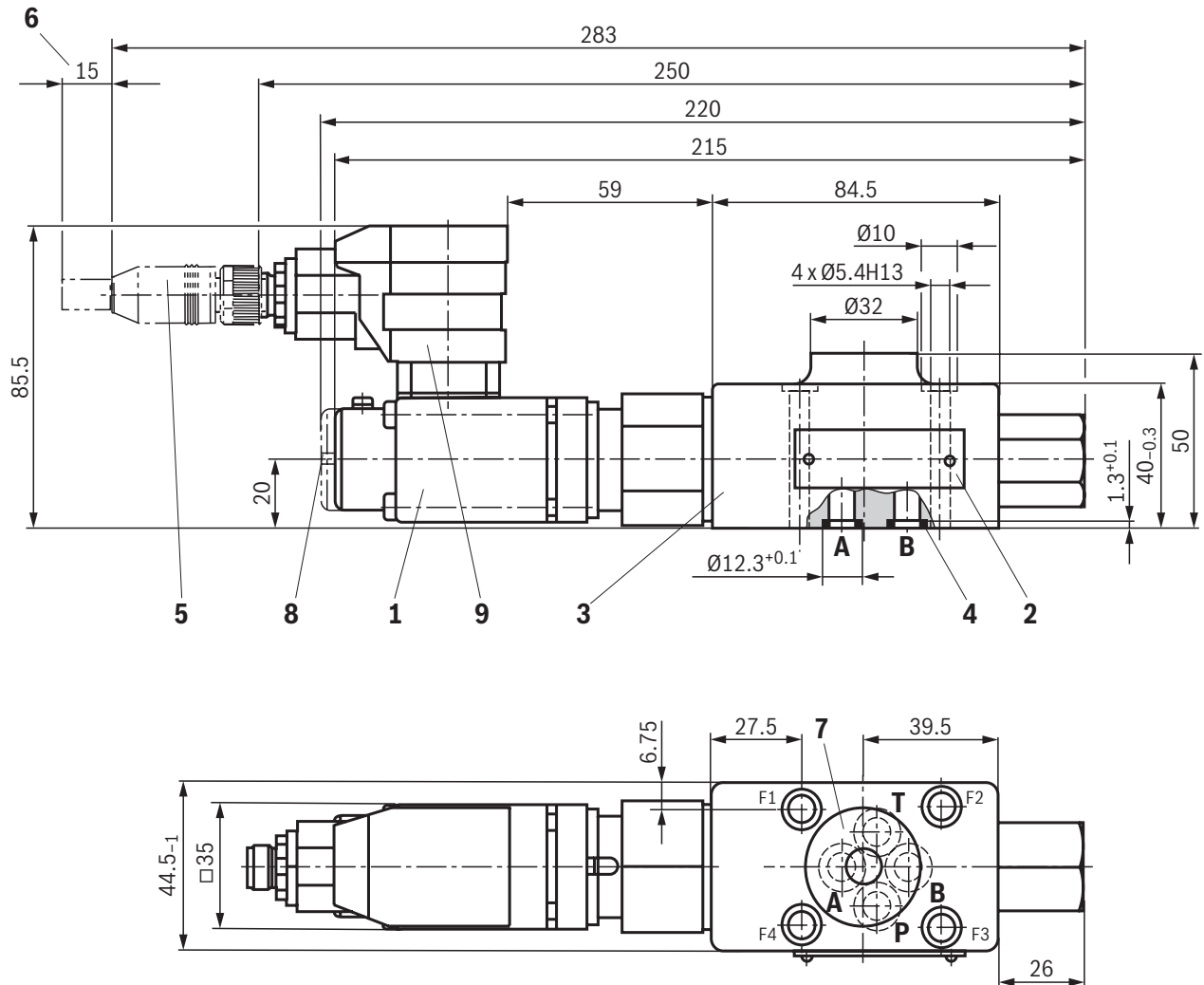

- 1 Proportional solenoid without manual override
- 2 Name plate
- 3 Valve housing
- 4 Identical seal rings for ports A, B, P and T
- 5 Mating connector, separate order, see page 18
- 6 Space required for removing the mating connector
- 7 Porting pattern according to ISO 4401-03-02-0-05
- 8 Proportional solenoid with manual override
- 9 Integrated electronics (OBE)

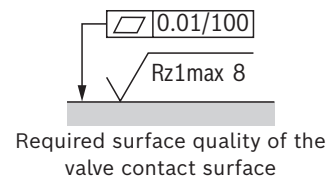

**Valve mounting screws and subplates**, see page 18.



**Notice:**

The dimensions are nominal dimensions which are subject to tolerances.

**Dimensions:** Type ZDRE  
(dimensions in mm)

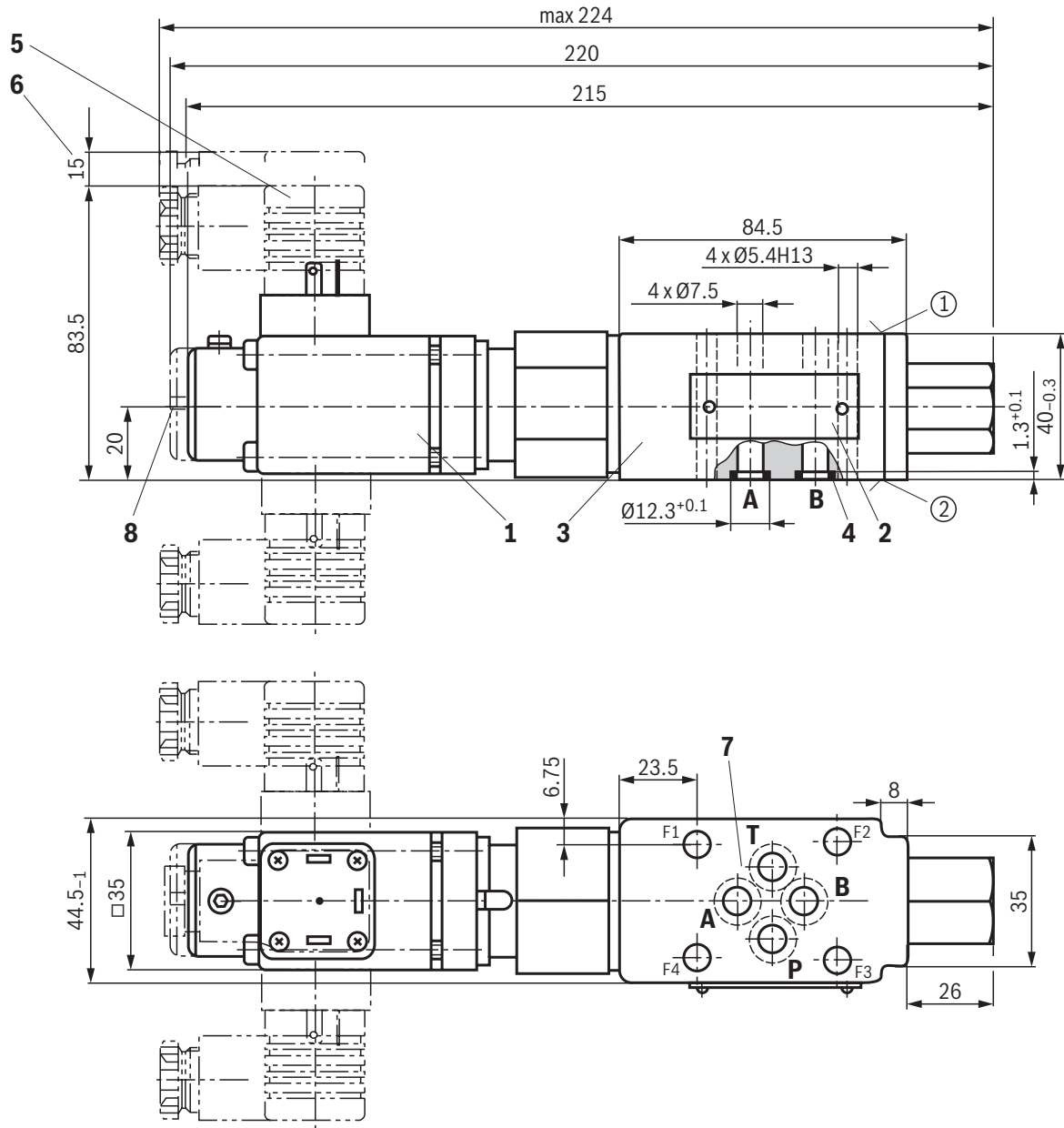

① component side

② plate side

- 1 Proportional solenoid without manual override
- 2 Name plate
- 3 Valve housing
- 4 Identical seal rings for ports A, B, P and T
- 5 Mating connector, separate order, see page 18
- 6 Space required for removing the mating connector
- 7 Porting pattern according to ISO 4401-03-02-0-05
- 8 Proportional solenoid with manual override

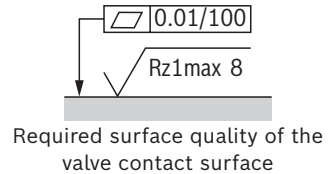

**Valve mounting screws** and **subplates**, see page 18.

**Notice:**

The dimensions are nominal dimensions which are subject to tolerances.

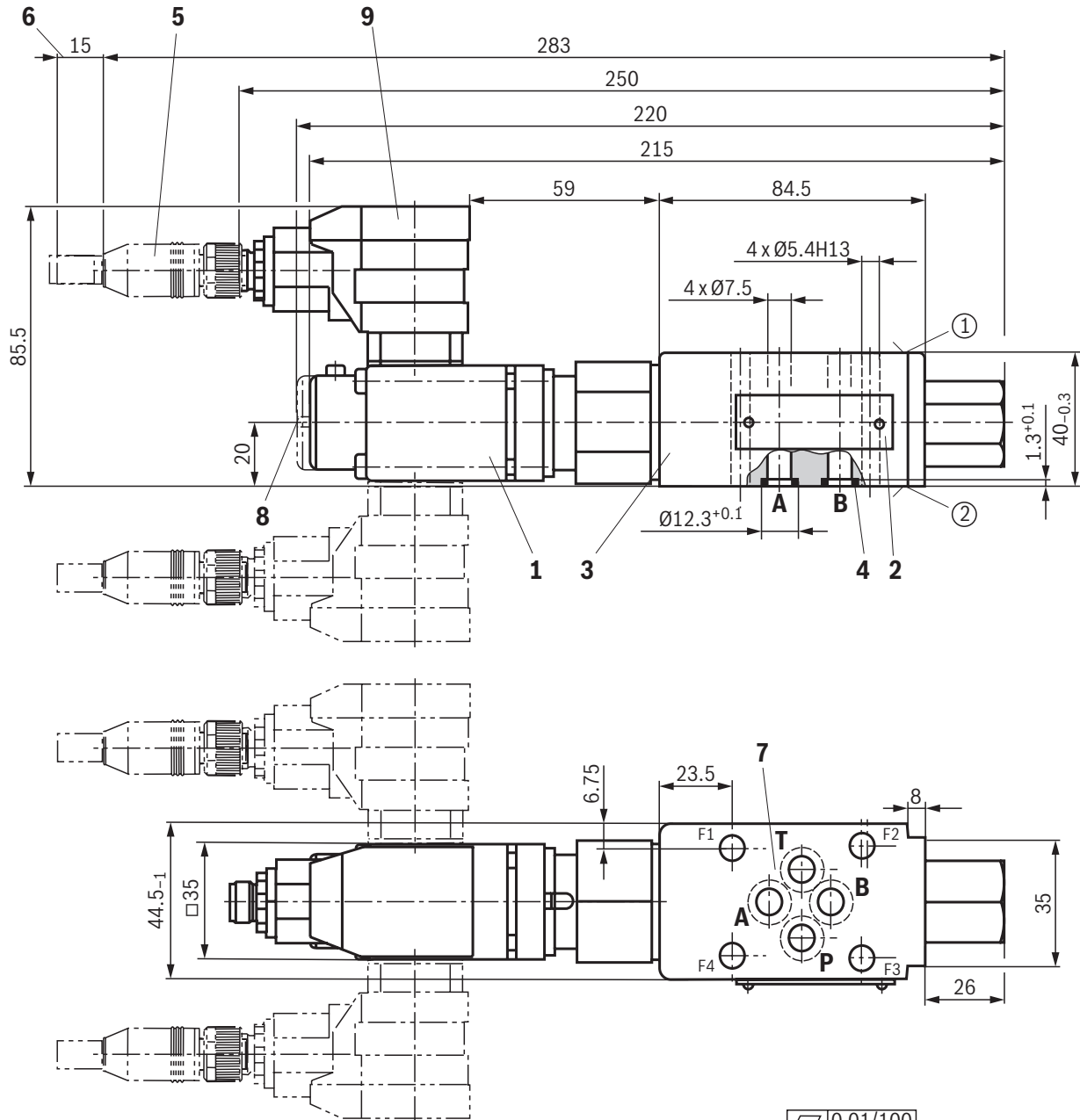

**Dimensions:** Type ZDREE  
 (dimensions in mm)

- ① component side
- ② plate side

- 1 Proportional solenoid without manual override
- 2 Name plate
- 3 Valve housing
- 4 Identical seal rings for ports A, B, P and T
- 5 Mating connector, separate order, see page 18
- 6 Space required for removing the mating connector
- 7 Porting pattern according to ISO 4401-03-02-0-05
- 8 Proportional solenoid with manual override
- 9 Integrated electronics (OBE)

Required surface quality of the valve contact surface

**Valve mounting screws and subplates, see page 18.**

**Notice:**

The dimensions are nominal dimensions which are subject to tolerances.

## Dimensions

### Valve mounting screws (separate order)

Type	Quantity	Hexagon socket head cap screws	Material number
DRE(E) ...	4	ISO 4762 - M5 x 50 - 10.9-fZn-240h-L Friction coefficient $\mu_{\text{total}} = 0.09 \dots 0.14$ ; tightening torque $M_A = 7 \text{ Nm} \pm 10\%$	R913043758
ZDRE(E) ...	4	ISO 4762 - M5 - 10.9-fZn-240h-L Friction coefficient $\mu_{\text{total}} = 0.09 \dots 0.14$ ; tightening torque $M_A = 7 \text{ Nm} \pm 10\%$	-



#### Notice:

The tightening torque of the hexagon socket head cap screws refers to the maximum operating pressure.

**Subplates** (separate order) with porting pattern according to ISO 4401-03-02-0-05 see data sheet 45100.

## Accessories (separate order)

### External control electronics

	Type	Data sheet
Modular design	VT-MSPA1-2X	30232

### Mating connectors and cable sets

Type	Designation	Version	Short designation	Material number	Data sheet
(Z)DRE ...	Mating connector; for valves with "K4" connector, 2-pole + PE, design A	Without circuitry, M16 x 1.5, 12 ... 240 V, "b"	Z4	R901017011	08006
(Z)DREE ...	Cable sets for valves with "K24", "K35" and "K72" connectors, 4-pole	M12 x 1, straight	VT-SSPA1-1X/M12/1/V00	R901241656	
		M12 x 1, angled	T-SSPA1-1X/M12/2/V00	R901241651	

Bosch Rexroth AG  
Industrial Hydraulics  
Zum Eisengießer 1  
97816 Lohr am Main, Germany  
Phone +49 (0) 93 52/40 30 20  
my.support@boschrexroth.de  
www.boschrexroth.de

© All rights reserved to Bosch Rexroth AG, also regarding any disposal, exploitation, reproduction, editing, distribution, as well as in the event of applications for industrial property rights.  
The data specified above only serve to describe the product. No statements concerning a certain condition or suitability for a certain application can be derived from our information. The information given does not release the user from the obligation of own judgment and verification.  
It must be remembered that our products are subject to a natural process of wear and aging.

Bosch Rexroth AG  
Industrial Hydraulics  
Zum Eisengießer 1  
97816 Lohr am Main, Germany  
Phone +49 (0) 93 52/40 30 20  
my.support@boschrexroth.de  
www.boschrexroth.de

© All rights reserved to Bosch Rexroth AG, also regarding any disposal, exploitation, reproduction, editing, distribution, as well as in the event of applications for industrial property rights.  
The data specified above only serve to describe the product. No statements concerning a certain condition or suitability for a certain application can be derived from our information. The information given does not release the user from the obligation of own judgment and verification.  
It must be remembered that our products are subject to a natural process of wear and aging.

## DRE(E); ZDRE(E) | Proportional pressure reducing valve, pilot-operated

Bosch Rexroth AG  
Industrial Hydraulics  
Zum Eisengießer 1  
97816 Lohr am Main, Germany  
Phone +49 (0) 93 52/40 30 20  
my.support@boschrexroth.de  
www.boschrexroth.de

© All rights reserved to Bosch Rexroth AG, also regarding any disposal, exploitation, reproduction, editing, distribution, as well as in the event of applications for industrial property rights.  
The data specified above only serve to describe the product. No statements concerning a certain condition or suitability for a certain application can be derived from our information. The information given does not release the user from the obligation of own judgment and verification.  
It must be remembered that our products are subject to a natural process of wear and aging.