

# Proportional pressure relief valve, direct operated, increasing characteristic curve KBPS.8A



- ▶ Size 8
- ▶ Series A
- ▶ Maximum working pressure 420 bar
- ▶ Maximum flow 2 l/min

## Features

- ▶ Cartridge valve
- ▶ Mounting cavity R/T-8A
- ▶ Direct operated proportional valve for limiting system pressure
- ▶ Suitable for mobile and industrial applications
- ▶ Actuated by proportional solenoid with central thread and removable coil
- ▶ Rotatable solenoid coil
- ▶ In case of power failure, minimum pressure is set
- ▶ Setpoint value pressure characteristic curve can be externally set using control electronics

## Contents

Type code	2
Preferred types	3
Functional description	3
Technical data	4
Characteristic curves	7
Permissible working range	11
Dimensions	13
Mounting cavity	14
Available individual components	15
Related documentation	16

## Type code

01	02	03	04	05	06	07	08	09	10	11	12
<b>KBPS</b>		<b>8</b>	<b>A</b>	<b>A</b>	<b>/</b>	<b>H</b>	<b>C</b>		<b>V</b>		<b>*</b>

### Valve type

01	Proportional pressure relief valve, direct operated (pilot control valve)	<b>KBPS</b>
----	---	-------------

### Pressure stage

02	Up to 30 bar	<b>B</b>
	Up to 50 bar	<b>C</b>
	Up to 100 bar	<b>F</b>
	Up to 150 bar	<b>H</b>
	Up to 210 bar	<b>L</b>
	Up to 250 bar	<b>N</b>
	Up to 315 bar	<b>P</b>
	Up to 350 bar	<b>R</b>
	Up to 420 bar	<b>T</b>

03	Size 8	<b>8</b>
----	--------	----------

04	If setpoint value = 0, minimum pressure is set	<b>A</b>
----	--	----------

05	Series	<b>A</b>
----	--------	----------

### Mounting cavity

06	Mounting cavity R/T-8A (see page 14)	<b>H</b>
----	--------------------------------------	----------

07	Proportional solenoid, switching in oil	<b>C</b>
----	---	----------

### Supply voltage

08	Control electronics 12 V DC	<b>G12</b>
	Control electronics 24 V DC	<b>G24</b>

### Electrical connection<sup>1)</sup>

09	Device connector according to DIN EN 175301-803	<b>K4</b>
	Device connector 2-pin, DT 04-2P (DEUTSCH)	<b>K40</b>
	Device connector 2-pin, Junior Timer (AMP)	<b>C4</b>

### Sealing material

10	FKM (fluorocarbon rubber)	<b>V</b>
----	---------------------------	----------

### Solenoid coil

11	Standard variant	<b>No code</b>
	24 V / 800 mA	<b>-8</b>

12	Further details in plain text	<b>*</b>
----	-------------------------------	----------

<sup>1)</sup> Plug-in connectors are not included in the scope of delivery and must be ordered separately, see data sheet 08006.

## Preferred types

Type	Material number
KBPSC8AA/HCG24K4V	R901049804
KBPSF8AA/HCG24K4V	R901049817
KBPSL8AA/HCG24K4V	R901027408
KBPSN8AA/HCG24K4V	R901049877
KBPSP8AA/HCG24K4V	R901047007

Type	Material number
KBPSR8AA/HCG24K4V	R901049860
KBPST8AA/HCG24K40V	R901045871
KBPSL8AA/HCG24K4V-8	R901053398
KBPSP8AA/HCG24C4V-8	R901132980
KBPSR8AA/HCG24C4V-8	R901128882

## Functional description

### General

Valves of type KBPS are direct operated proportional pressure relief valves (pilot control valves) in seat design and are used to limit the pressure in hydraulic systems. Their primary components are a pole tube (3), a solenoid coil (4), a valve seat (5) and a poppet (6).

These valves can be used for infinitely adjusting the pressure to be limited depending on the setpoint value. Minimum pressure is set in case of power failure or if the setpoint value is 0.

### Basic principle

They are actuated by a proportional solenoid with central thread and removable coil. The inside of the solenoid is connected with the port T and filled with hydraulic fluid.

To set the system pressure, a setpoint value is specified using the control electronics. Depending on this setpoint value, the electronics controls the solenoid coil with electric current. The proportional solenoid converts the electric current into mechanical force that acts on the poppet (6) via the anchor plunger. The poppet (6) presses on the valve seat (5) and blocks the connection between port P and port T. If the hydraulic force on the poppet (6) is equal to the magnetic force, the valve regulates the set pressure by lifting the poppet (6) off the valve seat (5) thereby allowing the hydraulic fluid to flow from port P to port T. At setpoint value of zero, the minimum setting pressure is set.

### Notice

Occurring tank pressures (port T) are added to the set value at port P.

### ▼ KBPS.8A...

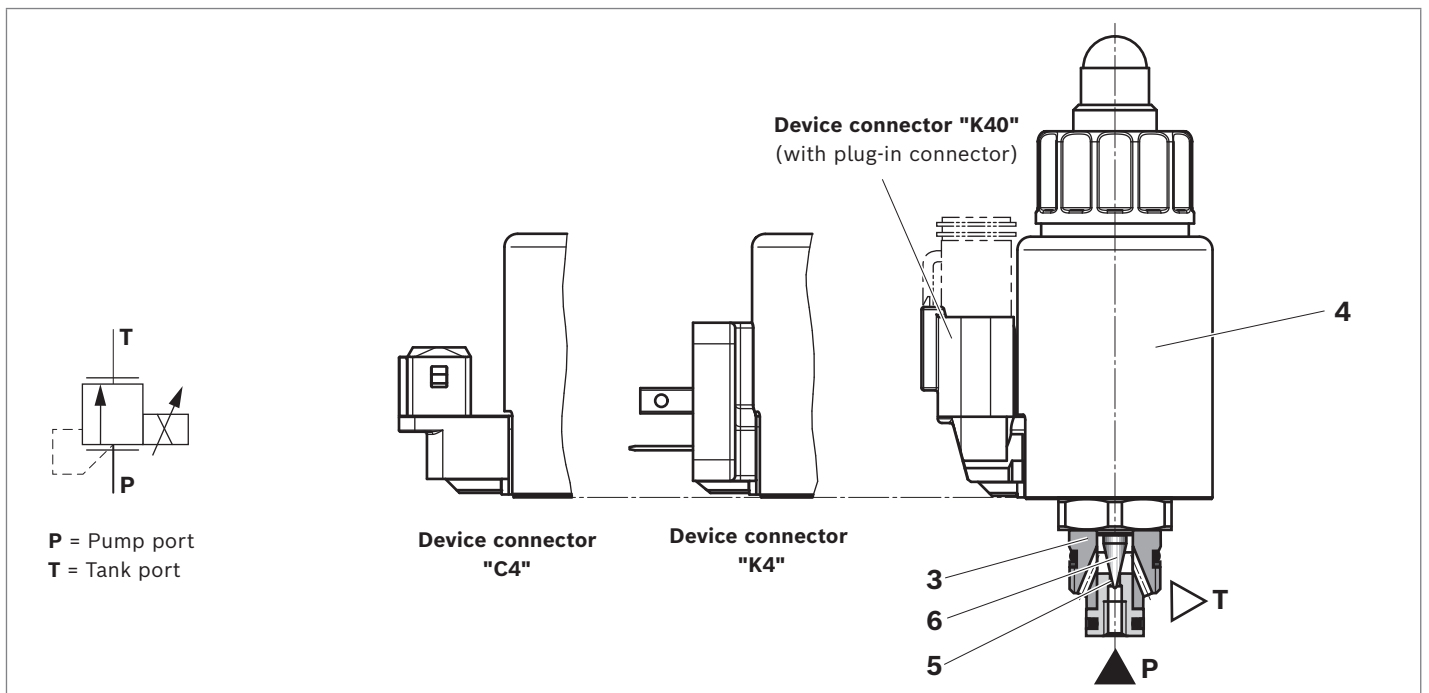

## Technical data

General		
Weight (approx.)	kg	0.45
Installation position		Any - if it is ensured that no air can collect upstream the valve. Otherwise we recommend suspend installation of the valve.
Ambient temperature range	°C	-20 to +120 (see pages 11 and 12)
Storage temperature range	°C	-20 to +80

## Environmental testing

Vibration test in accordance with DIN EN 60068-2/IEC 60068-2/two axes (X/Y)		
DIN EN 60068-2-6: 05/96	Sinusoidal vibration	10 cycles (5 Hz to 2000 Hz back to 5 Hz) with logarithmic sweep rate of 1 oct/min, 5 to 57 Hz, amplitude 1.5 mm (p-p), 57 to 2000 Hz, amplitude 10 g
IEC 60068-2-64: 05/93	Vibration (random) and broadband noise	20 to 2000 Hz, amplitude 0.05 g <sup>2</sup> /Hz (10 g RMS/30 g peak), testing time 24 h
DIN EN 60068-2-27: 03/95	Shock	Half sine 15 g/11 ms; 3× in positive, 3× in negative direction (6 single shocks total)
DIN EN 60068-2-29: 03/95	Continuous shock	Half sine 25 g/6 ms; 1000× in positive, 1000× in negative direction (2000 single shocks total)
Indication per axis		
Climate test in accordance with DIN/EN 60068-2/IEC 60068-2 (environmental audit)		
DIN EN 60068-2-1: 03/95	Storage temperature	-40 °C, dwell time 16 h
DIN EN 60068-2-2: 08/94		+110 °C, dwell time 16 h
DIN EN 60068-2-1: 03/95	Cold test	2 cycles, -25 °C, dwell time 2 h
DIN EN 60068-2-2: 08/94	Dry heat test	2 cycles, +120 °C, dwell time 2 h
IEC 60068-2-30: 1985	Humid heat, cyclical	Variant 2/ +25 °C to +55 °C 93% to 97% RH, 2 cycles of 24 h
Salt spray test in accordance with DIN 50021		
	<b>h</b>	<b>720</b>
→ Varnishing generally not necessary. If varnishing, note reduced radiation output.		

### Notice

For applications outside these values, please consult us!

Hydraulic				
Maximum working pressure <sup>1)</sup>	Port <b>P</b>	$p_A$	bar	420
Maximum return flow pressure	Port <b>T</b>	$p_T$	bar	210
Maximum set pressure <sup>2)</sup>		$p_{E \max}$		See setpoint value pressure characteristic curve on page 8
Minimum set pressure at setpoint value 0		$p_{E \min}$		See characteristic curves page 9 and 10
Maximum flow	<b>P → T</b>	$q_v$	l/min	2
Hydraulic fluid				See table below
Hydraulic fluid temperature range		$\vartheta$	°C	-20 to +80
Viscosity range		$\nu$	mm <sup>2</sup> /s	15 to 380
Maximum admissible degree of contamination of hydraulic fluid Cleanliness level per ISO 4406 (c)				Level 20/18/15 <sup>3)</sup>
Hysteresis <sup>4)</sup>				< 5% of maximum set pressure
Turnover voltage <sup>4)</sup>				< 0.5% of maximum set pressure
Responsiveness <sup>4)</sup>				< 0.5% of maximum set pressure
Setpoint value pressure characteristic curve tolerance	Setpoint value 100%			< 5% of maximum set pressure
	Setpoint value 0			< 2% of maximum set pressure
Step response ( $T_u + T_g$ ) 0 → 100% or 100% → 0		$t$	ms	70 (depending on system)

## Hydraulic fluid

Hydraulic fluid		Classification	Suitable sealing materials	Standards	Data sheet
Mineral oils		HL, HLP	FKM	DIN 51524	90220
Environmentally acceptable	Insoluble in water	HEES	FKM	ISO 15380	90221
	Soluble in water	HEPG	FKM	ISO 15380	90221

### Notice

- ▶ Further information and details on using other hydraulic fluids are available in the above data sheets or on request.
- ▶ Restrictions are possible with the technical valve data (temperature, pressure range, service life, maintenance intervals, etc.)!
- ▶ The flash point of the hydraulic fluid used must be 40 K above the maximum solenoid surface temperature.
- ▶ **Environmentally acceptable:** If environmentally acceptable hydraulic fluids are used that are also zinc-dissolving, there may be an accumulation of zinc.

1) The maximum working pressure is the aggregate of set pressure and return flow pressure!

2) The valves come preset. Changing the settings voids the warranty.

3) Cleanliness levels specified for the components must be maintained in the hydraulic systems. Effective filtration prevents malfunctions and simultaneously extends the service life of the components.

4) Measured with type RA2-1/10 analog amplifier, see data sheet 95230

<b>Electric</b>				
Voltage type			DC voltage	
Supply voltage	V	<b>12</b>	<b>24</b>	<b>24 ("–8")</b>
Maximum solenoid current	mA	1760	1200	800
Coil resistance	Cold value at 20 °C	Ω	2.3	4.8
	Maximum warm value	Ω	3.8	7.9
Duty cycle (ED) <sup>5)</sup>	%	100 (See characteristic curve page 11 and 12)		
Maximum coil temperature <sup>6)</sup>	°C	150		
Type of protection according to ISO 20653	Connector version "K4"	IP6K5 <sup>7)</sup>		
	Connector version "C4"	IP6K6K <sup>7)</sup>		
		IP6K9K <sup>7)</sup> (only with Rexroth type R901022127)		
	Connector version "K40"	IP6K7 and IP6K9K <sup>7)</sup>		
Control electronics (separate order)		Proportional amplifier type VT-SSPA1, data sheet 30116		
		Proportional amplifier type VT-MSPA, data sheet 30232		
		Analog amplifier type RA, data sheet 95230		
		BODAS controller type RC, data sheets 95204, 95205, 95206		
Recommended dither frequency (PMW)	Hz	300		
Design according to VDE 0580				

**Notice**

For the electrical connection, a protective earth (PE  $\perp$ ) connection is mandatory based on the specification.

5) Consult the manufacturer if planning to use > 2000 m above sea level.

6) Due to the occurring surface temperatures of the solenoid coils, the standards ISO 13732-1 and ISO 4413 must be observed!

7) With installed and locked plug-in connector. Plug-in connectors are not included in the scope of delivery and must be ordered separately, see data sheet 08006.

## Characteristic curves

### $p$ - $q_v$ flow characteristic curves

#### Pressure at port P depending on flow

(The characteristic curves were measured without back-pressure at port T.)

#### Notice

Characteristic curves measured with HLP46,  
 $\vartheta_{oil} = 40 \pm 5 \text{ } ^\circ\text{C}$  and 24 V coil.

#### ▼ Pressure stage 30 bar

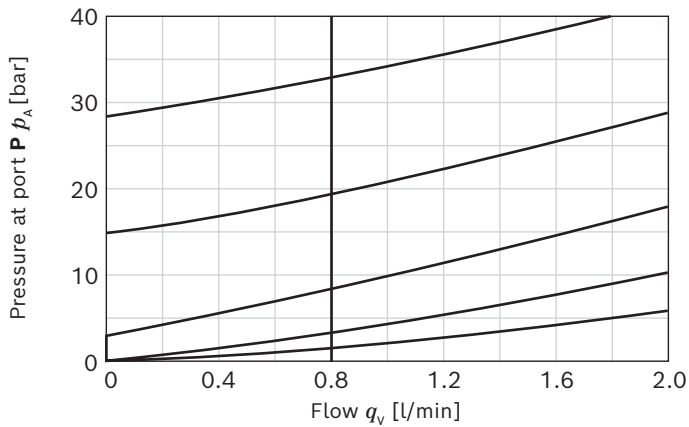

#### ▼ Pressure stage 150 bar

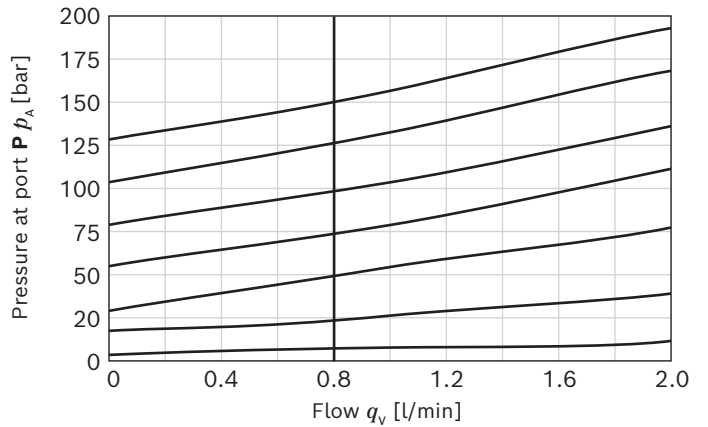

#### ▼ Pressure stage 50 bar

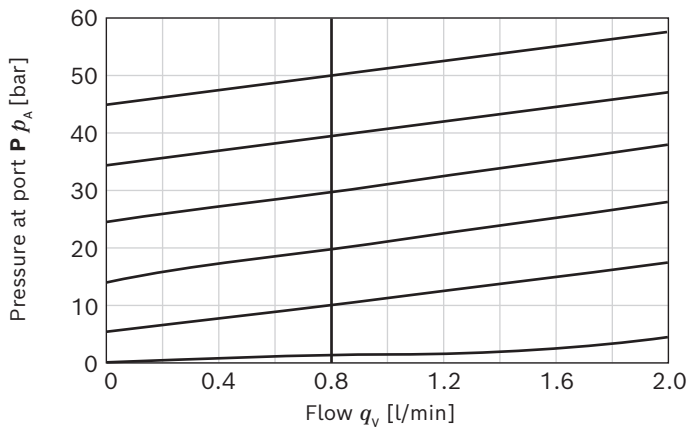

#### ▼ Pressure stage 210 bar

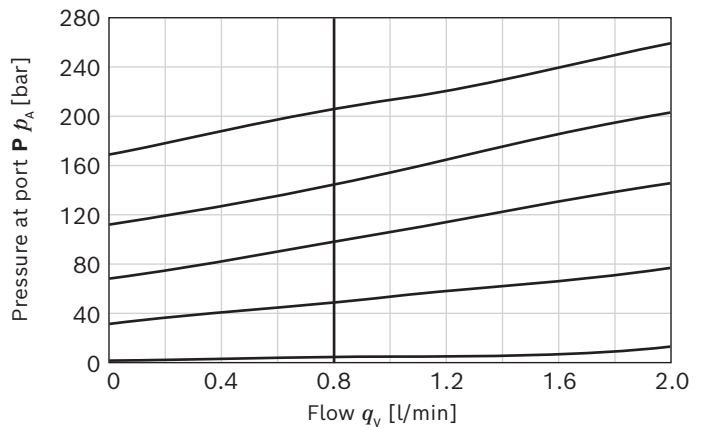

#### ▼ Pressure stage 100 bar

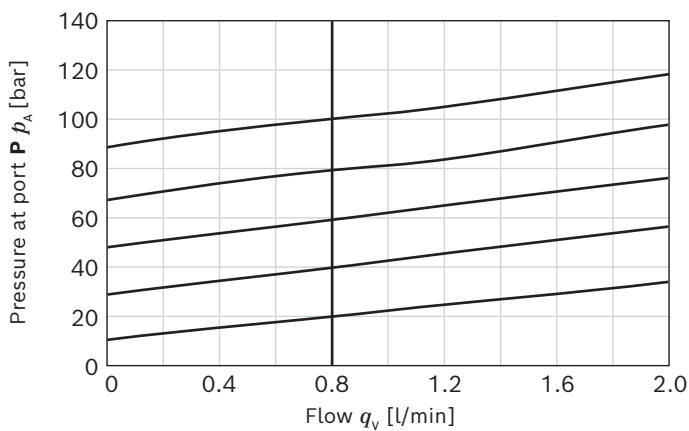

#### ▼ Pressure stage 250 bar

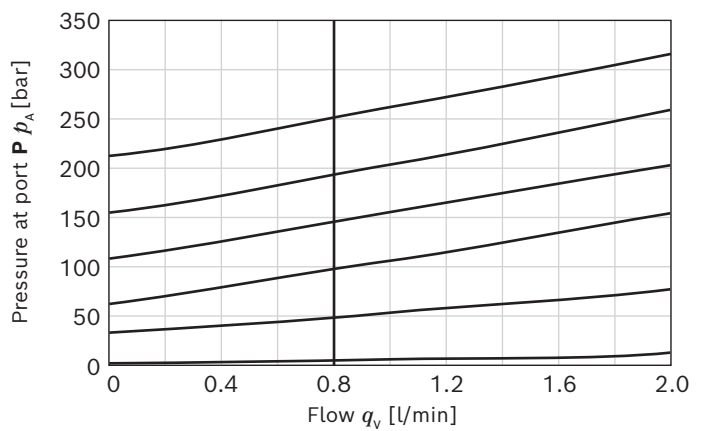

▼ **Pressure stage 315 bar**

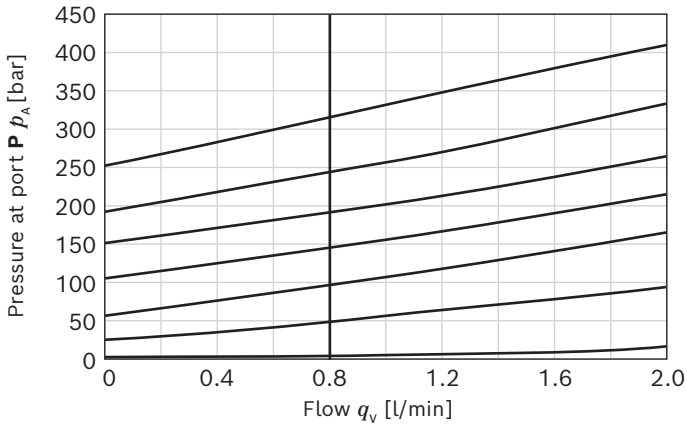

▼ **Pressure stage 350 bar**

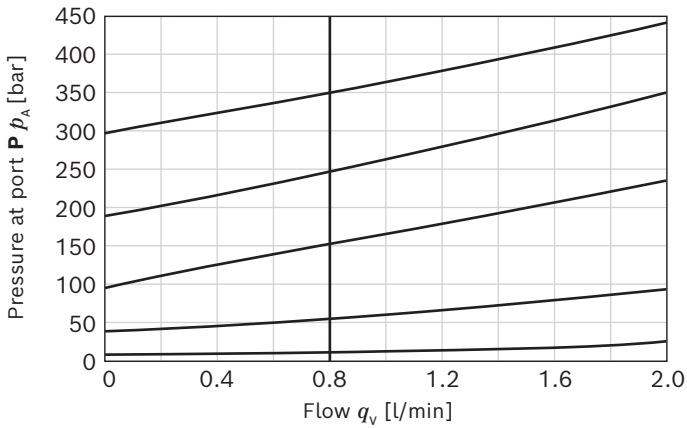

▼ **Pressure stage 420 bar**

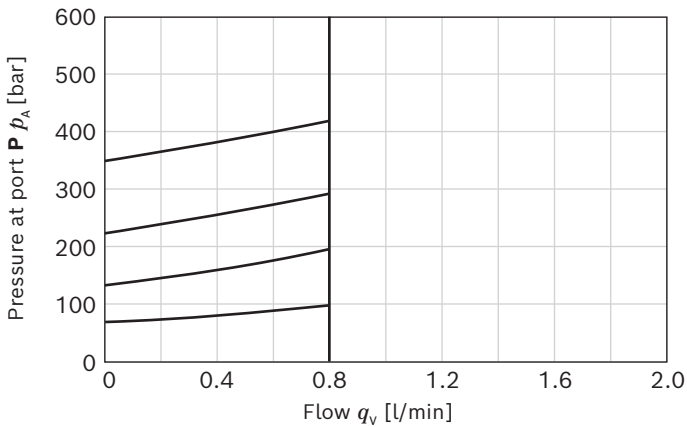

**p-I characteristic curves**

**Pressure at port P depending on the setpoint value**

(Flow = 0.8 l/min)

▼ **Pressure stage 30 to 210 bar**

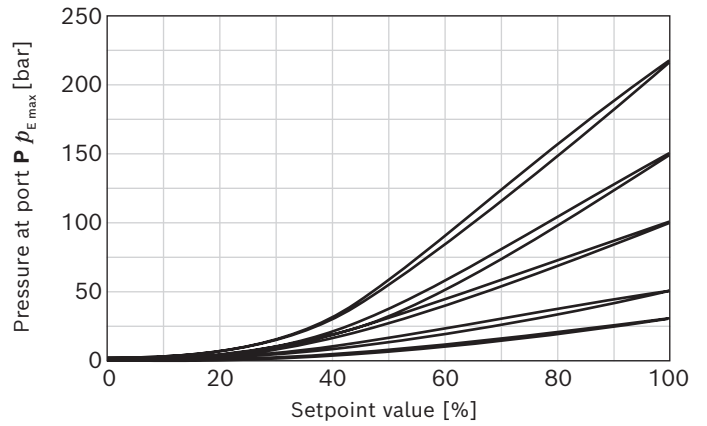

▼ **Pressure stage 250 to 420 bar**

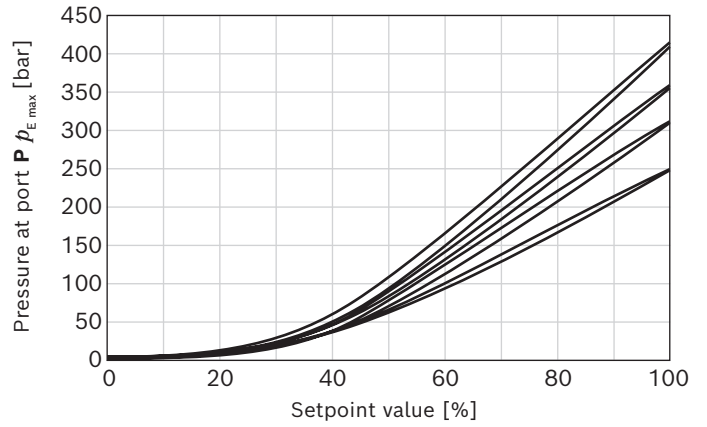

**Notice**

Characteristic curves measured with HLP46,  
 $\vartheta_{oil} = 40 \pm 5 \text{ } ^\circ\text{C}$  and 24 V coil.



**Minimum set pressure  $p_E$  at port P depending on flow at setpoint value 0**

(The characteristic curves were measured without back-pressure at port T.)

▼ **Pressure stage 30 bar**

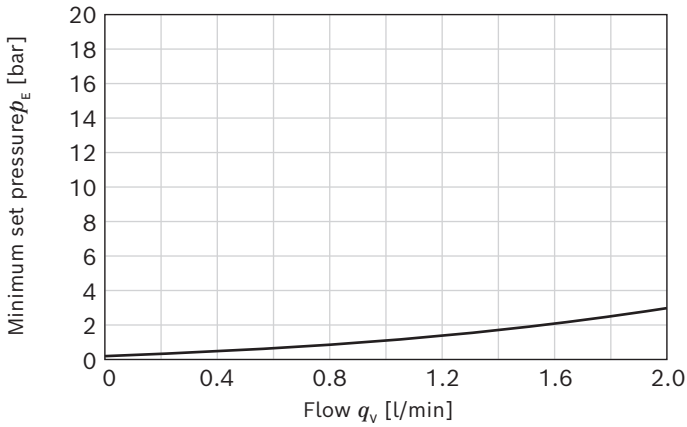

▼ **Pressure stage 150 bar**

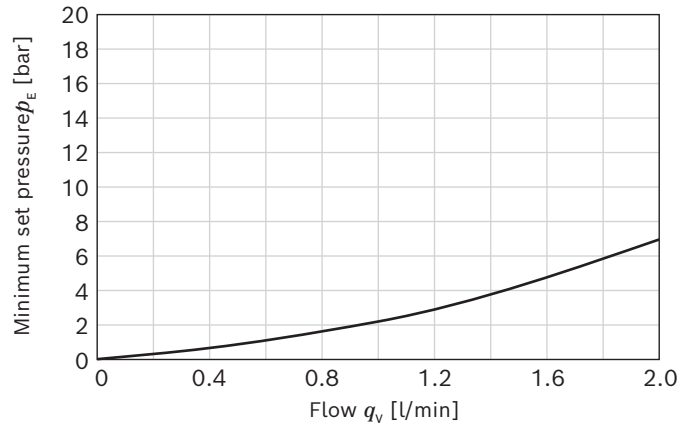

▼ **Pressure stage 50 bar**

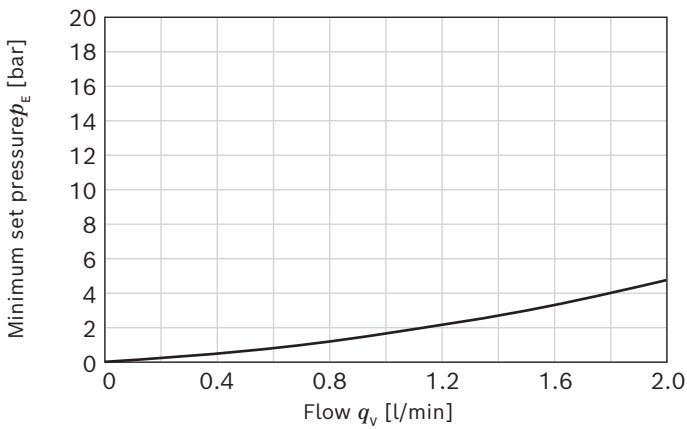

▼ **Pressure stage 210 bar**

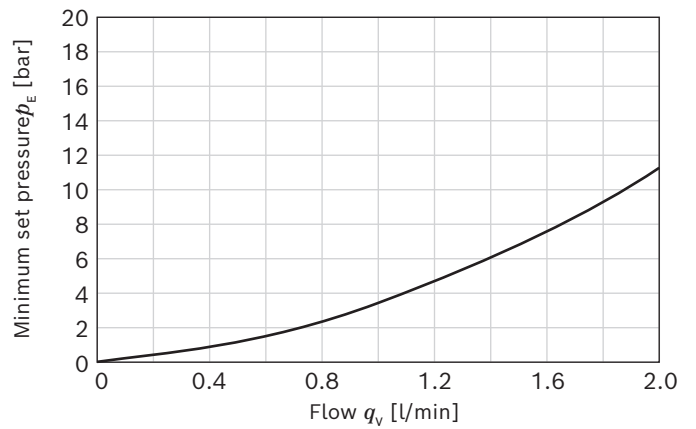

▼ **Pressure stage 100 bar**

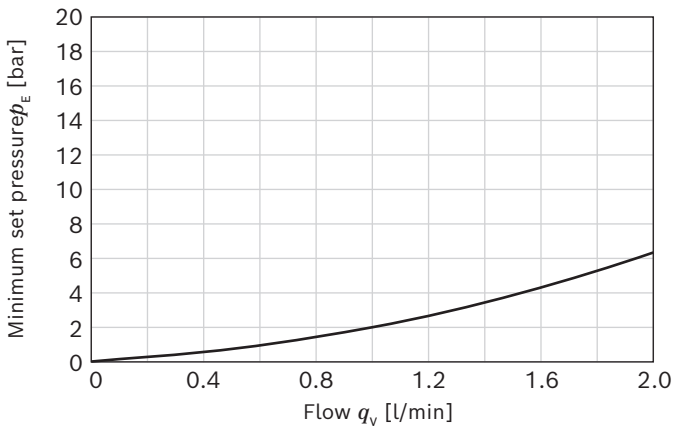

▼ **Pressure stage 250 bar**

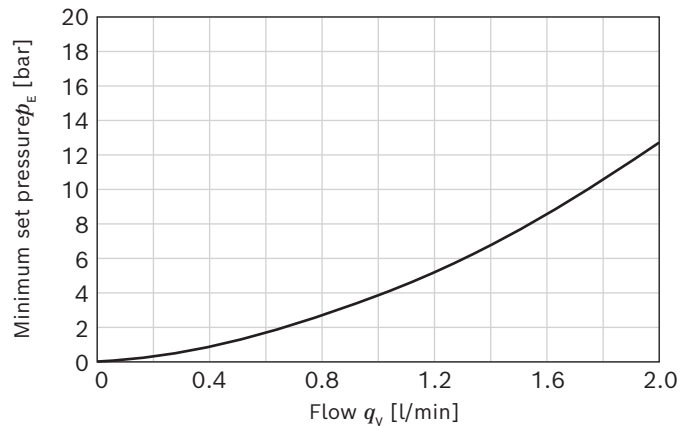

**Notice**

Characteristic curves measured with HLP46,  
 $\vartheta_{oil} = 40 \pm 5 \text{ } ^\circ\text{C}$  and 24 V coil.

▼ **Pressure stage 315 bar**

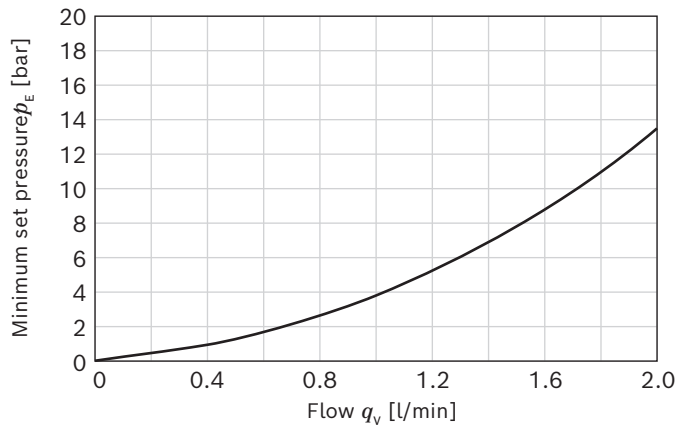

▼ **Pressure stage 350 bar**

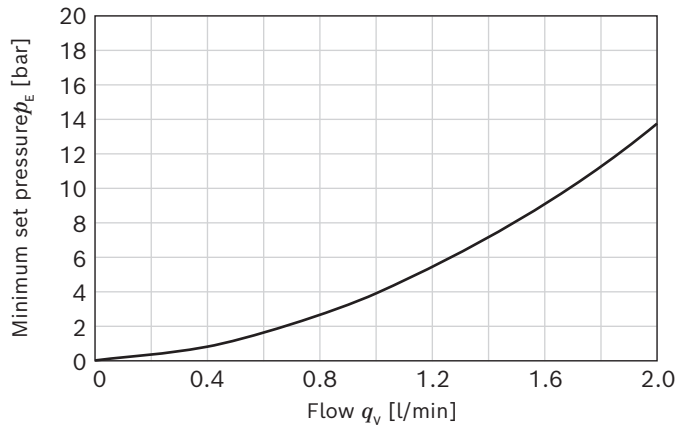

▼ **Pressure stage 420 bar**

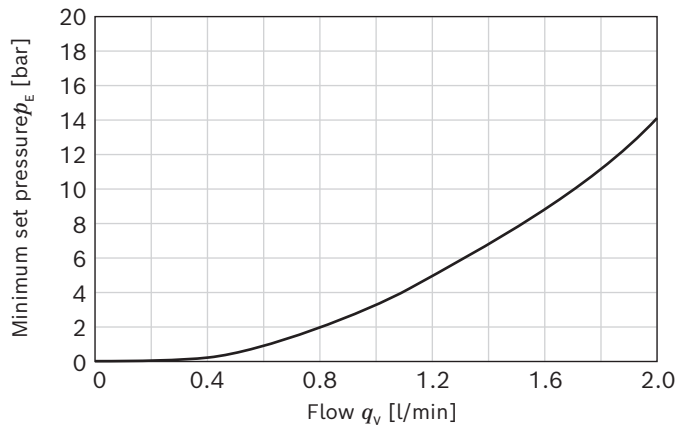

**Notice**

Characteristic curves measured with HLP46,  
 $\vartheta_{oil} = 40 \pm 5$  °C and 24 V coil.

## Permissible working range

### Minimum terminal voltage on the coil and relative duty cycle depending on the ambient temperature

#### ▼ Version "G12"

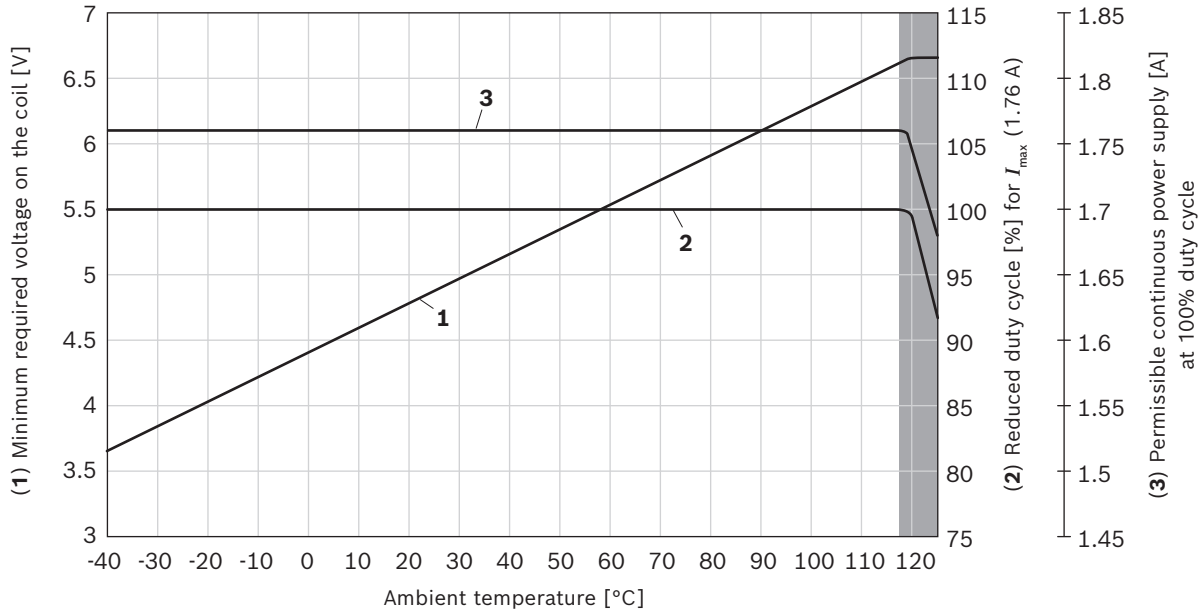

#### ▼ Version "G24"

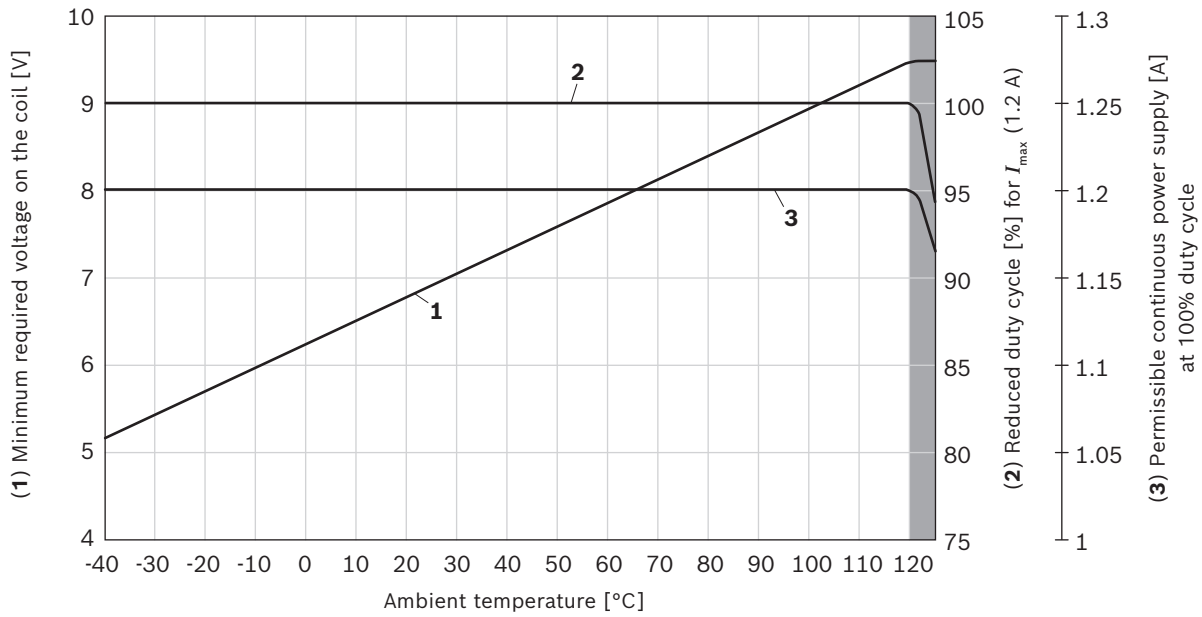

▼ Version "G24...-8"

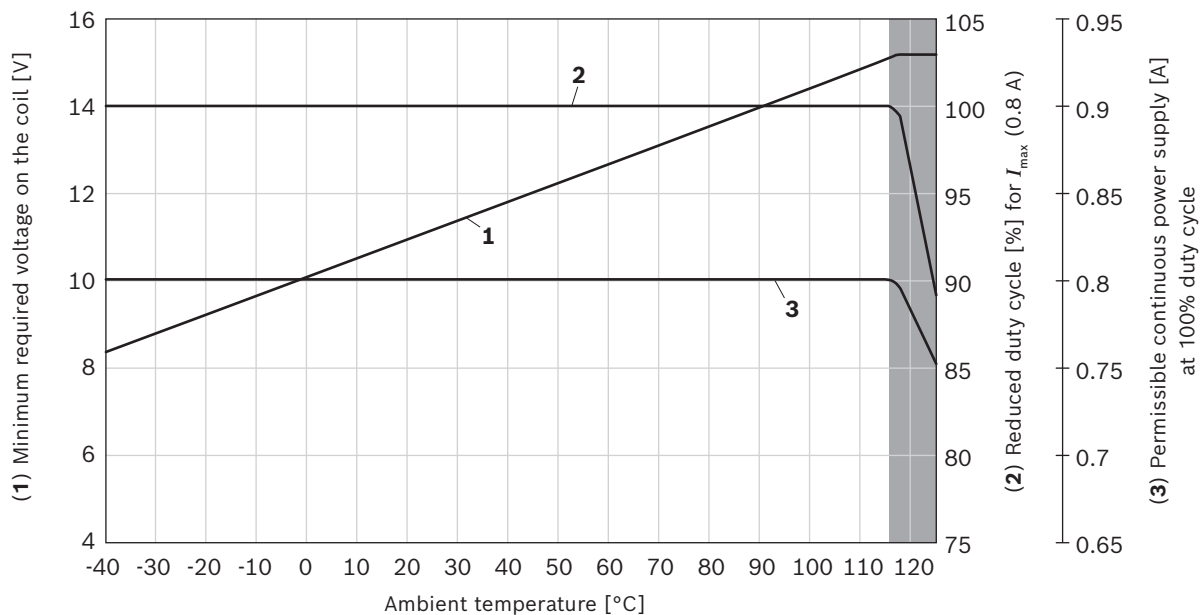

= Limited valve performance

**Notice**  
The characteristic curves were determined for coils with valve for medium test block size (80 x 80 x 80 mm), w/o flow in still air. Depending on installation conditions (block size, flow, air circulation, etc.), heat dissipation may be better. This increases the range of applications. In specific instances, unfavorable conditions may limit the range of applications.

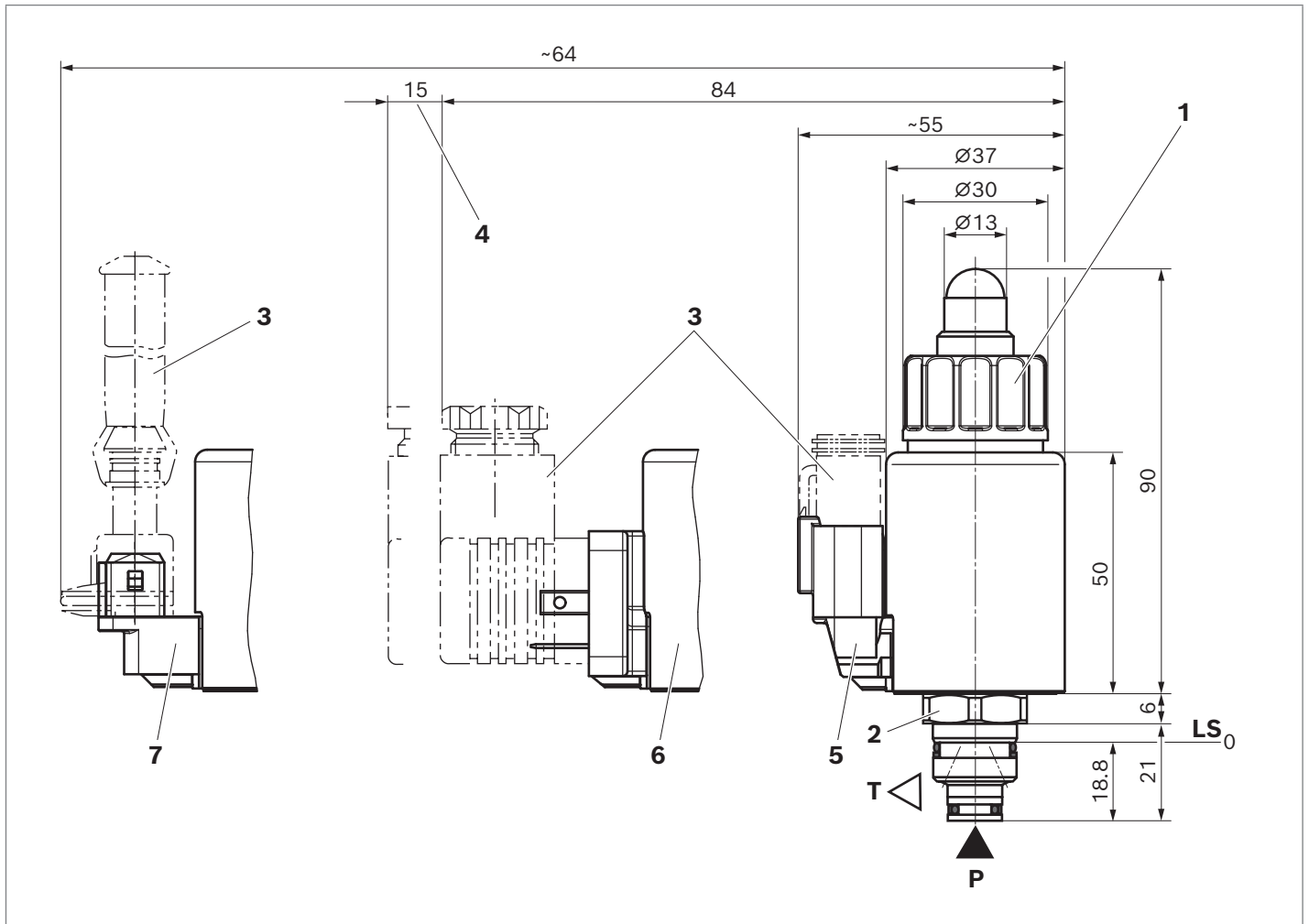
**Dimensions**▼ **KBPS.8A**

- 1 Nut, tightening torque  $M_A = 5+1$  Nm
- 2 Hexagon SW22, tightening torque  $M_A = 40+6$  Nm
- 3 Plug-in connectors, separate order, see data sheet 08006
- 4 Space required to remove the plug-in connector
- 5 Device connector "K40"
- 6 Device connector "K4"
- 7 Device connector "C4"

- P** = Pump port
- T** = Tank port
- LS** = location shoulder

## Mounting cavity

▼ R/T-8A; 2 ports; thread M16×1.5-6H

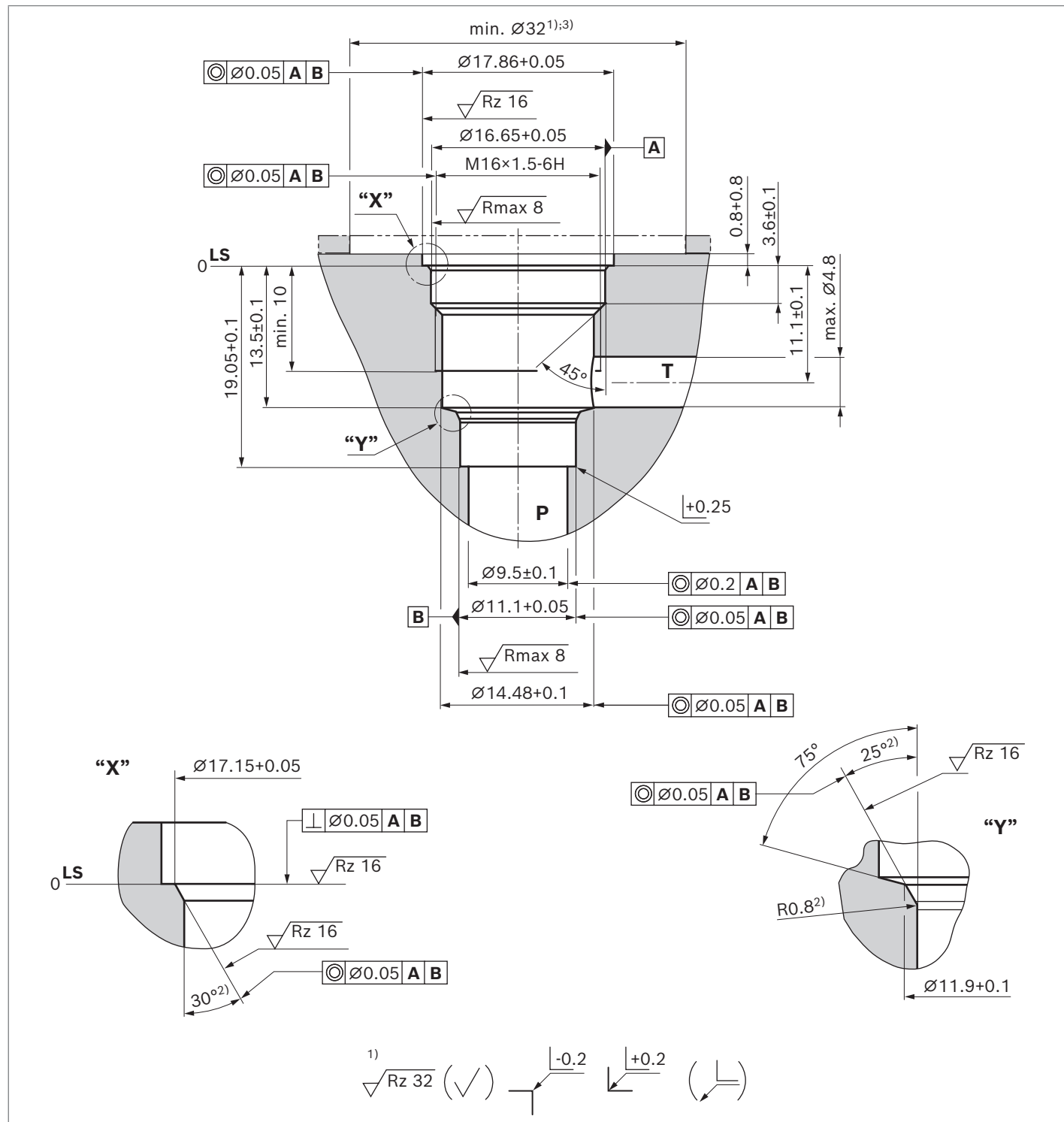

1) Deviating from T-8A

2) All seal ring insertion faces are rounded and free of burrs

3) At counterbore

Tolerance for all angles  $\pm 0.5^{\circ}$

LS = location shoulder

P = Pump port

T = Tank port

## Available individual components

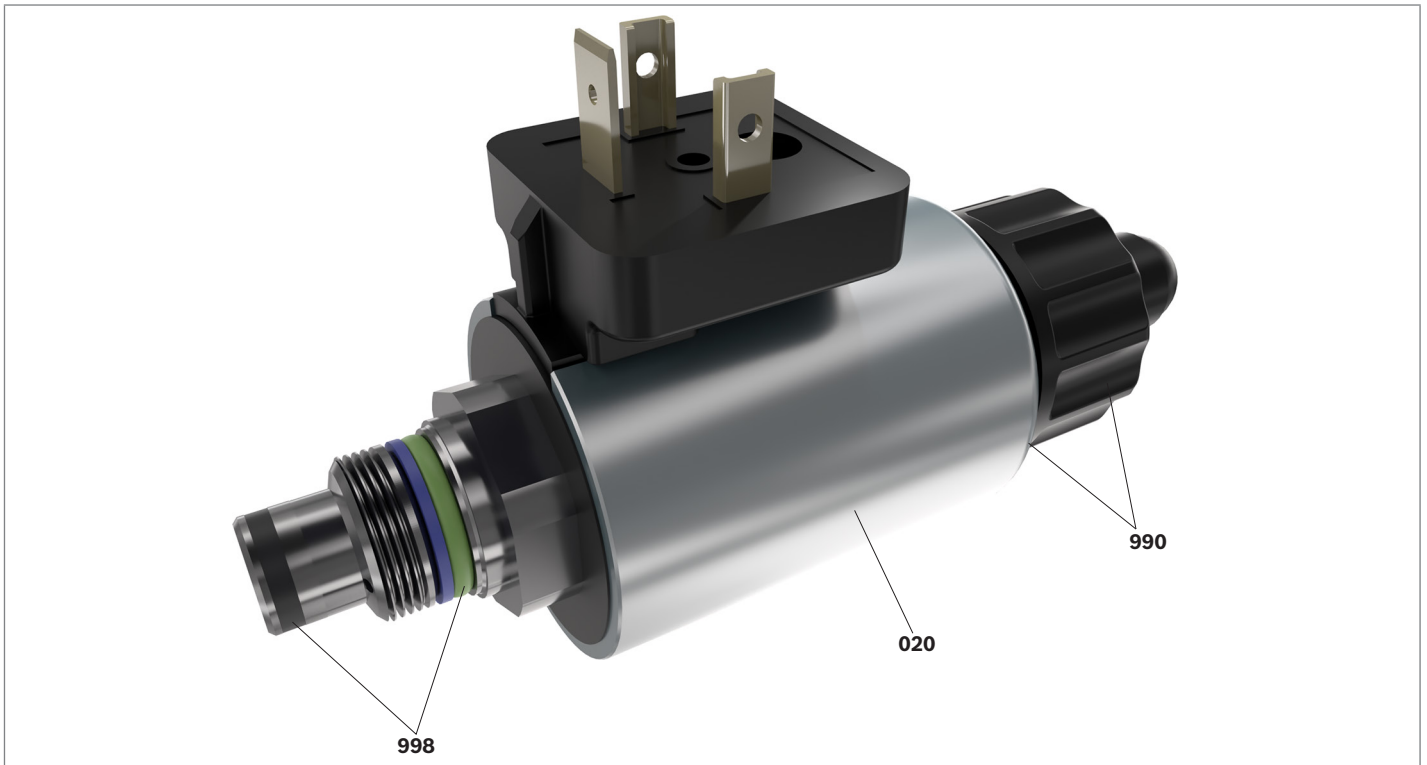

Item	Denomination		DC voltage	Material no.
020	Coil for single connection <sup>1)</sup>	Device connector "K4"	12 V	R901002932
			24 V	R901002319
			24 V / 800 mA	R901049962
		Device connector "K40"	12 V	R901003055
			24 V	R901003053
			24 V / 800 mA	R901050010
		Device connector "C4"	12 V	R901003044
			24 V	R901003026
			24 V / 800 mA	R901049963
990	Nut and seal ring for pole tube			R961010456
998	Seal kit of the valve			R961000376

<sup>1)</sup> Replacing the solenoid coil may result in a change of  $\pm 5\%$  in the factory pressure setting.

## Related documentation

- |   |               |                                 |
|---|---------------|---------------------------------|
| ▶ Control electronics:  |               |                                 |
| – Valve amplifiers for proportional valves                                | Type VT-SSPA1 | Data sheet 30116                |
| – Valve amplifiers for proportional valves<br>(Top hat rail installation) | Type VT-MSPA  | Data sheet 30232                |
| – Analog amplifier  | Type RA       | Data sheet 95230                |
| – BODAS controller  | Type RC       | Data sheets 95204, 95205, 95206 |
| ▶ Mineral oil-based hydraulic fluids                                      |               | Data sheet 90220                |
| ▶ Environmentally acceptable hydraulic fluids                             |               | Data sheet 90221                |
| ▶ MTTF <sub>D</sub> values  |               | Data sheet 90294                |

### **Bosch Rexroth AG**

Zum Eisengießer 1  
97816 Lohr am Main  
Germany  
Phone +49 9352 18-0  
info.ma@boschrexroth.de  
www.boschrexroth.com

© Bosch Rexroth AG 2022. All rights reserved, also regarding any disposal, exploitation, reproduction, editing, distribution, as well as in the event of applications for industrial property rights. The data specified within only serves to describe the product. No statements concerning a certain condition or suitability for a certain application can be derived from our information. The information given does not release the user from the obligation of own judgment and verification. It must be remembered that our products are subject to a natural process of wear and aging.